



Isolation Galvanic isolators for analogue and digital signals as well as HART® signals. A wide product range with both loop-powered and universal isolators featuring linearisation, inversion, and scaling of output signals.



Displays Programmable displays with a wide selection of inputs and outputs for display of temperature, volume, weight, etc. Feature linearisation, scaling, and difference measurement functions for programming via PReset software.



Ex barriers Interfaces for analogue and digital signals as well as HART® signals between sensors / I/P converters / frequency signals and control systems in Ex zone 0, 1 & 2. Feature options such as mathematical functions and 2 wire transmitter interfaces.



Temperature A wide selection of transmitters for DIN form B mounting and DIN rail modules with analogue and digital bus communication ranging from application-specific to universal transmitters.



Backplane Flexible motherboard solutions for system 5000 modules. Our backplane range features flexible 8 and 16 module solutions with configuration via PReplan 8470 – a PC program with drop-down menus.



DK Side 1

UK Page 17

FR Page 33

DE Seite 49

6 3 3 5

**2-Wire HART®
Transmitter**

No. 6335V106-IN (0550)
From ser. no. 000925001



SIGNALS THE BEST

2-TRÅDS HART®-TRANSMITTER

PRetrans 6335

Indholdsfortegnelse

Sikkerhedsinstruktion	2
Overensstemmelseserklæring	3
Anvendelse	4
Teknisk karakteristik	4
Montage / installation.....	4
Applikationer	5
Bestillingsskema.....	6
Elektriske specifikationer	6
Tilslutninger	10
Blokdiagram	12
Programmering.....	13
Loop Link.....	13
HART®-modem.....	14
HART®-kommunikator	15
Forbindelse af transmittere i multidrop.....	16
Appendix:	
FM Installation Drawing No. 6335QF01	66
CSA Installation Drawing No. 6335QC02	68

Sikkerhedsinstruktion

Ex-installation:

For sikker installation af 6335B i eksplosionsfarligt område skal følgende overholdes. Installation må kun foretages af kvalificeret personale, der er bekendt med de nationale og internationale love, direktiver og standarder, der gælder for området.

Produktionsår fremgår af de to første cifre i serienummeret.

Reparation:

Reparation af modulet må kun foretages af PR electronics A/S.

OVERENSSTEMMELSESERKLÆRING

Som producent erklærer

PR electronics A/S

Lerbakken 10

DK-8410 Rønde

hermed at følgende produkt:

Type: 6335

Navn: 2-Tråds HART[®]-transmitter

er i overensstemmelse med følgende direktiver og standarder:

EMC-direktivet 2004/108/EF og senere tilføjelser

EN 61326

Denne erklæring er udgivet i overensstemmelse med EMC-direktivets paragraf 10, stk. 1. For specifikation af det acceptable EMC-niveau henvises til modulets elektriske specifikationer.

ATEX-direktivet 94/9/EF og senere tilføjelser

EN 50014 og EN 50020

ATEX-certifikat: 99ATEX126961

Bemyndiget organ for CENELEC / ATEX: **UL International Demko A/S 0539**

Rønde, 22. dec. 2005



Peter Rasmussen
Producentens underskrift

2-TRÅDS HART[®]-TRANSMITTER PRetrans 6335

- Indgang for RTD, TC, Ohm eller mV
- Ekstrem målenøjagtighed
- HART[®]-kommunikation
- Galvanisk isolation
- 1- eller 2-kanals version

Anvendelse:

- Temperaturlineariseret måling med Pt100...Pt1000, Ni100...Ni1000 eller termoelementføler.
- Differens- eller gennemsnitstemperaturmåling på 2 modstands- eller TC-følere.
- Omsætning af lineær modstandsændring til standard analogt strømsignal, f.eks. fra ventiler eller ohmske niveaustave.
- Forstærkning af bipolært mV-signal til et standard 4...20 mA strømsignal.
- Kobling af op til 15 kanaler til et digitalt 2-leder signal med HART[®]-kommunikation.

Teknisk karakteristik:

- PR6335 kan af brugeren i løbet af få sekunder programmeres til at måle indenfor alle normerede temperaturområder.
- RTD- og modstandsindgangen har kabelkompensering for 2-, 3- og 4-leder tilslutning.
- Udgangssignalet kan programmeres til en begrænsning.
- Der er løbende sikkerhedscheck af gemte data.
- Følfejl-detektering iht. retningslinierne i NAMUR NE 89.

Montage / installation:

- Monteres på DIN-skinne, vertikalt eller horisontalt. Med 2-kanals versionen kan der installeres 84 kanaler pr. meter.
- **NB:** Som Ex-barriere for 6335B anbefaler vi 5106B.

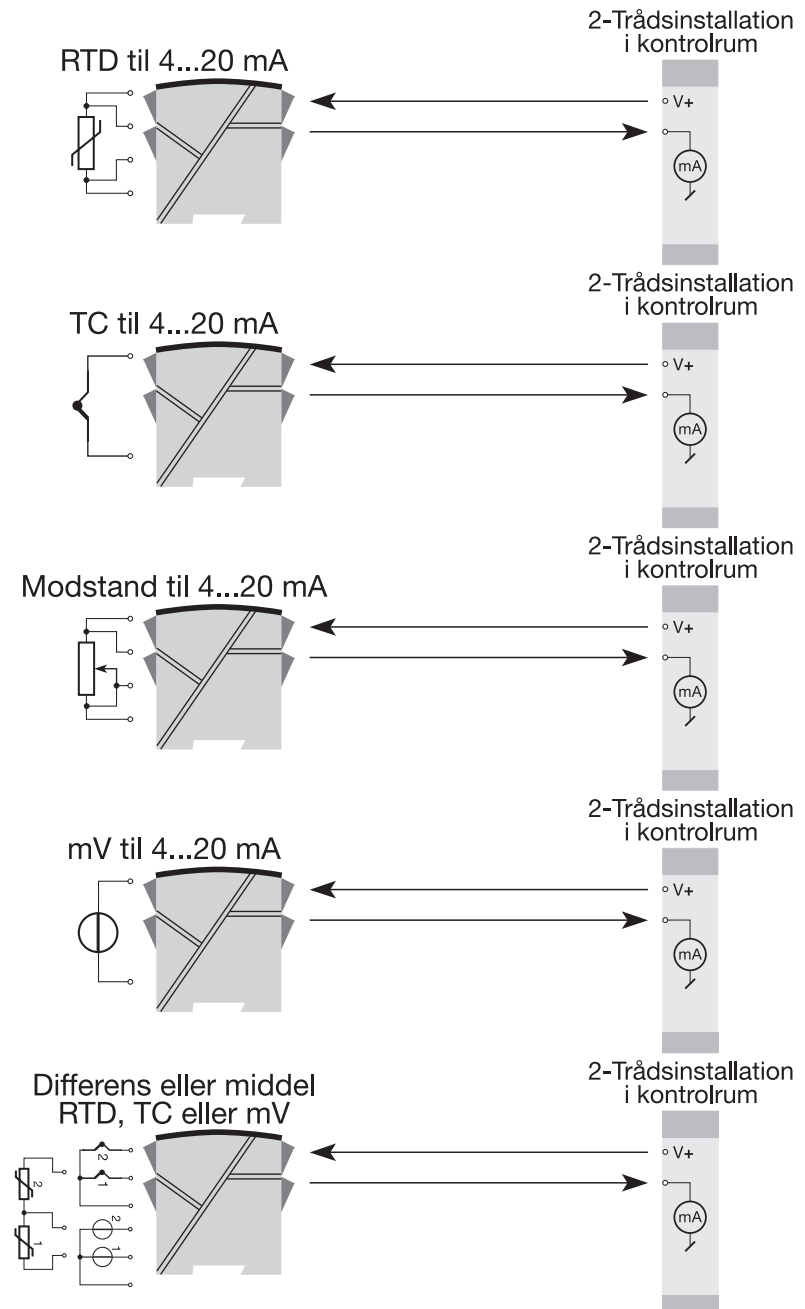

Bestillingsskema: 6335

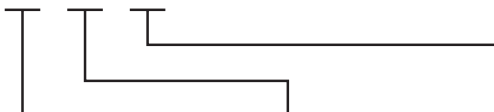

Type	Version	Galvanisk isolation	Kanaler
6335	Standard : A	1500 VAC : 2	Enkelt : A
	ATEX : B		Dobbelt : B
	FM og ATEX : C		
	CSA, FM og ATEX : D		

***NB!** Husk at bestille CJC-stik type 5910 / 5910EEx (kanal 1) og 5913 / 5913EEx (kanal 2) i forbindelse med TC-indgange med intern CJC.

Elektriske specifikationer:

Specifikationsområde:

-40°C til +60°C

Fælles specifikationer:

Forsyningsspænding DC

Standard 8,0...35 VDC

ATEX, FM og CSA, 6335B, C og D..... 8,0...28 VDC

Isolationsspænding, test / drift 1,5 kVAC / 50 VAC

Isolationsspænding, kanal 1 / kanal 2:

Standard, 6335A3,75 kVAC

ATEX, FM og CSA, 6335B, C og D.....1500 VAC

Opvarmningstid 30 s

Kommunikationsinterface..... Loop Link og HART®

Signal- / støjforhold..... Min. 60 dB

Reaktionstid (programmerbar) 1...60 s

EEPROM fejlcheck < 10 s

Signaldynamik, indgang..... 22 bit

Signaldynamik, udgang..... 16 bit

Kalibreringstemperatur 20...28°C

Nøjagtighed, størst af generelle og basisværdier:

Generelle værdier		
Indgangstype	Absolut nøjagtighed	Temperaturkoefficient
Alle	≤ ±0,05% af span	≤ ±0,005% af span / °C

Basisværdier		
Indgangstype	Basis nøjagtighed	Temperaturkoefficient
Pt100 og Pt1000	≤ ±0,1°C	≤ ±0,005°C/°C
Ni100	≤ ±0,2°C	≤ ±0,005°C/°C
Lin. R	≤ ±0,1 Ω	≤ ±5 mΩ/°C
Volt	≤ ±10 μV	≤ ±0,5 μV/°C
TC-type: E, J, K, L, N, T, U	≤ ±0,5°C	≤ ±0,025°C/°C
TC-type: B, R, S, W3, W5	≤ ±1°C	≤ ±0,1°C/°C

EMC-immunitetspårvirkning.....	< ±0,1% af span
Udvidet EMC-immunitet:	
NAMUR NE 21, A kriterium, gniststøj.....	< ±1% af span

Virkning af forsyningsspændings-

ændring < 0,005% af span / VDC

Max. ledningskvadrat 1 x 1,5 mm² flerkoret ledning

Luftfugtighed < 95% RH (ikke kond.)

Mål..... 109 x 23,5 x 104 mm

Tæthedsgrad (hus / klemme) IP50 / IP20

Vægt (1 / 2 kanaler)..... 145 / 185 g

Elektriske specifikationer indgange:

Max. nulpunktsforskydning (offset) 50% af valgt numerisk max. værdi

RTD- og lineær modstandsindgang:

RTD-type	Min. værdi	Max. værdi	Min. span
Pt100	-200°C	+850°C	10°C
Ni100	-60°C	+250°C	10°C
Lin. R	0 Ω	7000 Ω	25 Ω

Kabelmodstand pr. leder (max.) 5 Ω
 Følerstrøm Nom. 0,2 mA
 Virkning af følerkabelmodstand
 (3- / 4-leder) < 0,002 Ω / Ω
 Følerfejlsdetektering Ja
 Kortslutningsdetektering Hvis 0% > 30 Ω

TC-indgange:

Type	Min. temperatur	Max. temperatur	Min. span	Norm
B	+400°C	+1820°C	100°C	IEC584
E	-100°C	+1000°C	50°C	IEC584
J	-100°C	+1200°C	50°C	IEC584
K	-180°C	+1372°C	50°C	IEC584
L	-100°C	+900°C	50°C	DIN 43710
N	-180°C	+1300°C	50°C	IEC584
R	-50°C	+1760°C	100°C	IEC584
S	-50°C	+1760°C	100°C	IEC584
T	-200°C	+400°C	50°C	IEC584
U	-200°C	+600°C	50°C	DIN 43710
W3	0°C	+2300°C	100°C	ASTM E988-90
W5	0°C	+2300°C	100°C	ASTM E988-90

Koldt loddestedskomp. (CJC)..... < ±1,0 °C
 Ekstern CJC med Ni100 eller Pt100 -40 ≤ T_{omg.} ≤ 135°C
 Følerfejlsdetektering Ja
 Følerfejlsstrøm:
 under detektering..... Nom. 33 µA
 ellers..... 0 µA
 Kortslutningsdetektering Hvis 0% > 5 mV

Spændingsindgange:

Måleområde -800...+800 mV
 Min. måleområde (span)..... 2,5 mV
 Indgangsmodstand 10 MΩ

Strømodgange:

Signalområde 4...20 mA
 Min. signalområde..... 16 mA
 Opdateringstid..... 440 ms
 (660 ms for diff.)
 Fast udgangssignal Mellem 4 og 20 mA
 Udgangssignal ved EEpromfejl ≤ 3,5 mA
 Belastningsmodstand..... ≤ (V_{forsyn.} - 8) / 0,023 [Ω]
 Belastningsstabilitet < ±0,01% af span / 100 Ω

Følerfejlsdetektering:

Programmerbar 3,5...23 mA
 NAMUR NE43 Upscale 23 mA
 NAMUR NE43 Downscale..... 3,5 mA

Ex- / I.S.-data:

Udgang, klemme 11...14, (21...24):
 U_i : 28 VDC
 I_i : 120 mADC
 P_i : 0,84 W
 L_i : 10 µH
 C_i : 1,0 nF

Indgang, klemme 41...44, (51...54):

U_o : 9,6 VDC
 I_o : 28 mADC
 P_o : 67,2 mW
 L_o : 35 mH
 C_o : 3,5 µF

EEx- / I.S.-godkendelse:

DEMKO 99ATEX126961  II 1 G
 EEx ia IIC T1...T6
 Max. omgivelsestemp. for T1...T6 60°C
 ATEX, må anvendes i zone..... 0, 1 eller 2
 FM, må anvendes i..... IS, Class I, Div. 1, Group A, B, C, D
 IS, Class I, Zone 0, AEx ia IIC
 Entity, FM Installation Drawing No. 6335QF01
 CSA, må anvendes i..... IS, Class I, Div. 1, Group A, B, C, D,
 Ex ia IIC
 IS, Class I, Zone 0, AEx ia IIC
 Installation Drawing No. 6335QC02

GOST R godkendelse:

Standard: VNIIM Cert. no. Ross DK.ME48.V01899
 Ex: VNIIFTRI Cert. no. Ross DK.GB06.V00100

Overholdte myndighedskrav:

Standard:
 EMC 2004/108/EF
 Emission og immunitet EN 61326
 ATEX 94/9/EF EN 50014 og EN 50020
 FM, ASCN 3600, 3611, 3610
 CSA, CAN / CSA C22.2 No. 157, E60079-11, UL 913

Af span = Af det aktuelt valgte område

Tilslutninger:

Indgange:

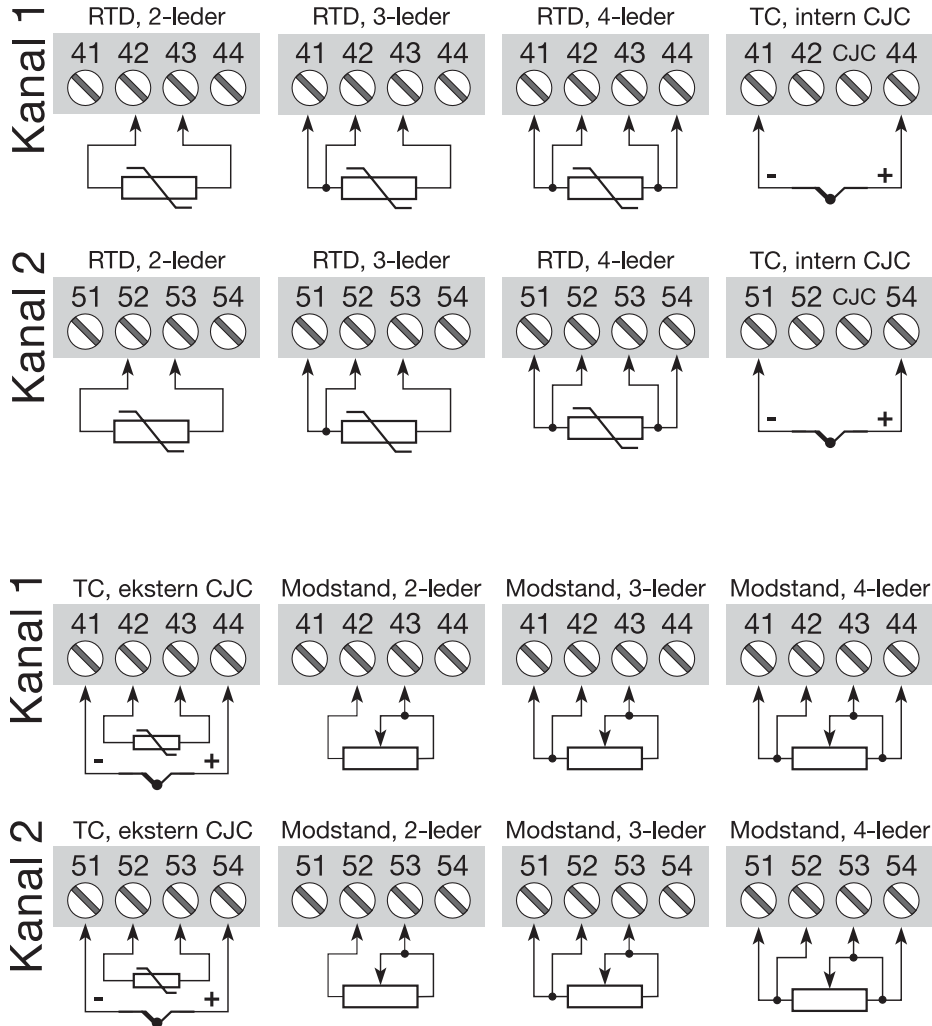

Tilslutninger:

Indgange:

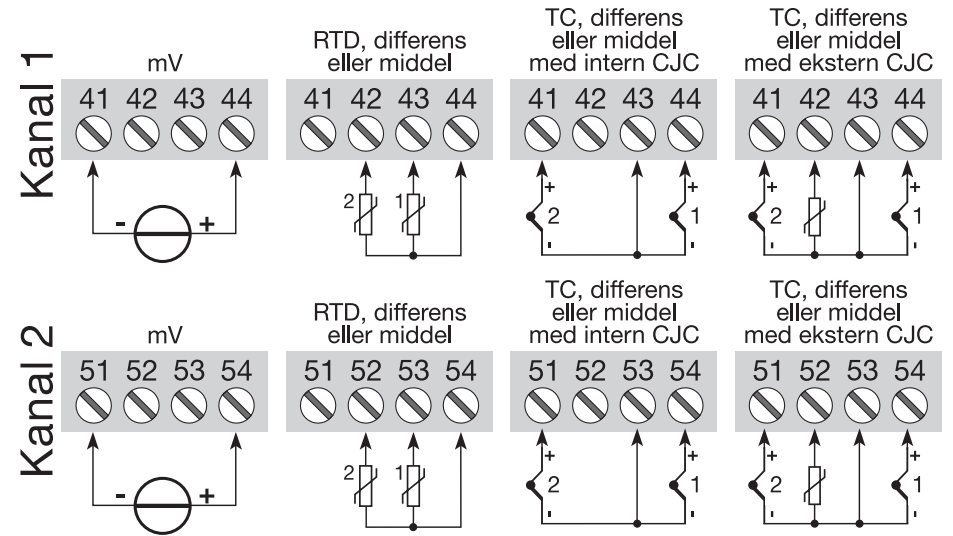

Udgange:

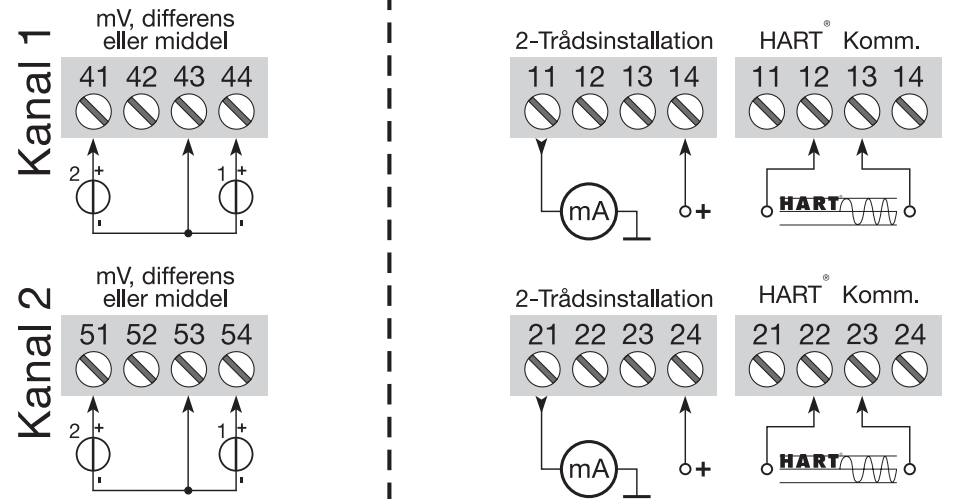

BLOKDIAGRAM:

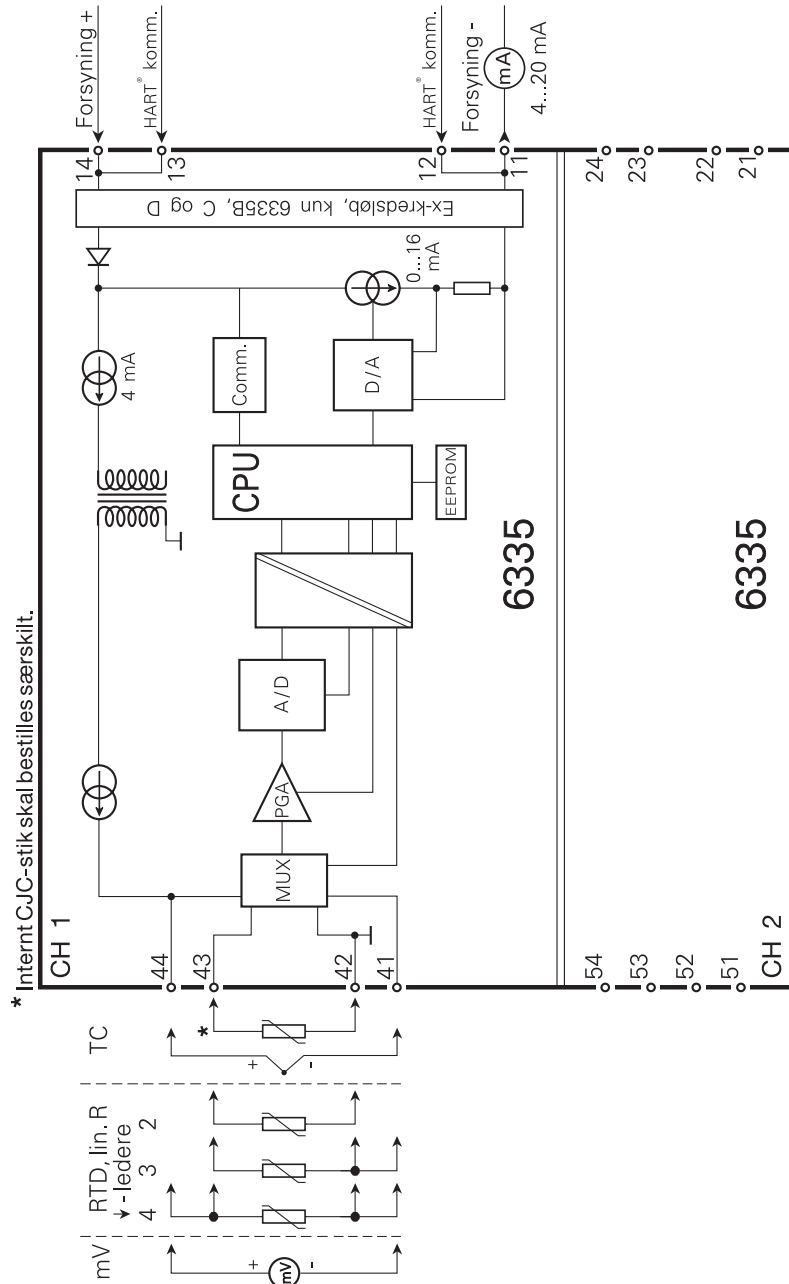

Programmering:

PRetrans 6335 kan konfigureres på 3 måder:

1. Med PR electronics A/S' kommunikationsinterface Loop Link og PReset PC konfigurationssoftware.
2. Med HART[®]-modem og PReset PC konfigurationssoftware.
3. Med HART[®]-kommunikator indeholdende PR electronics A/S' DDL driver.

1: Loop Link:

Ved programmering henvises til tegningen nedenfor og hjælpefunktionen i PReset programmet.

Ved kommunikation med ikke-installerede moduler må stikkene 11, 12, 13, 14 (kanal 1) og 21, 22, 23, 24 (kanal 2) afmonteres, så kommunikationsinterfacets tilslutningsklemmer kan forbindes til stikbenene.

Loop Link må ikke benyttes til kommunikation med moduler installeret i Ex-område.

Bestilling: Loop Link

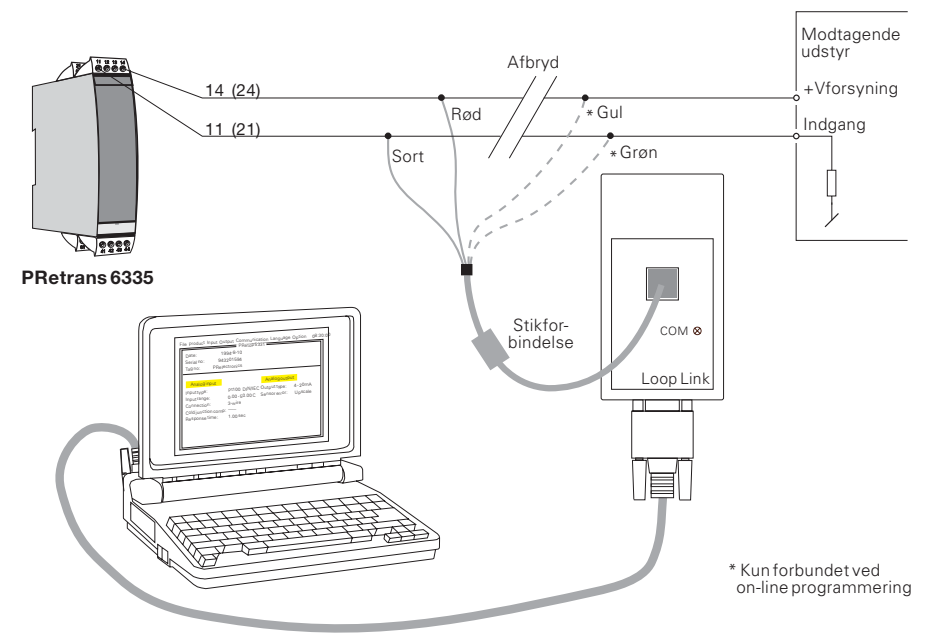

2: HART®-modem:

Ved programmering henvises til tegningen nedenfor og hjælpefunktionen i PReset-programmet.

Bestilling: HART®-modem 276D

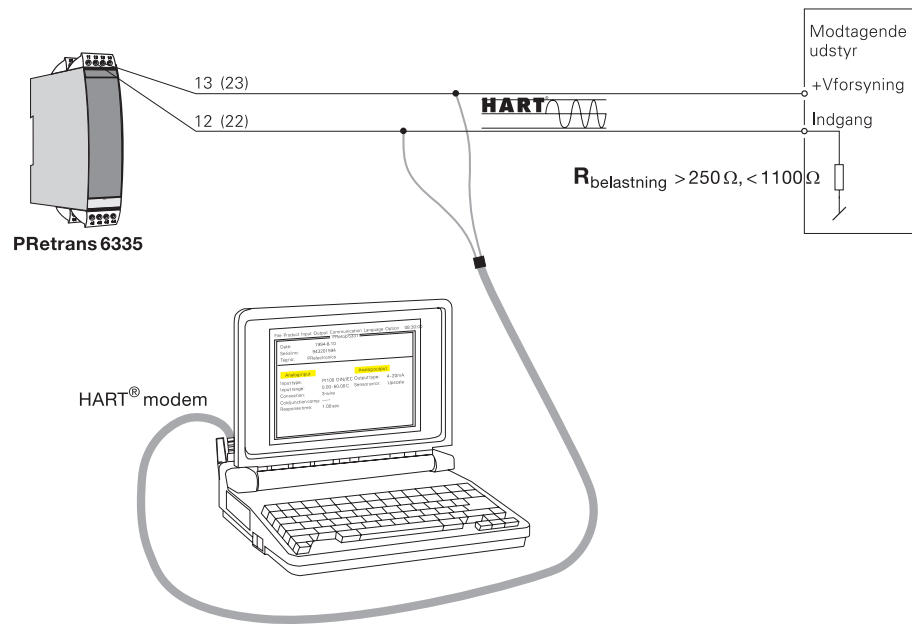

3: HART®-kommunikator:

Ved programmering henvises til tegningen nedenfor. For at få adgang til produktspecifikke kommandoer skal HART®-kommunikatoren indeholde PR electronics A/S' DDL driver. Denne kan rekvireres enten hos HART®-Communication Foundation eller hos PR electronics A/S.

Bestilling: HART®-kommunikator 275D

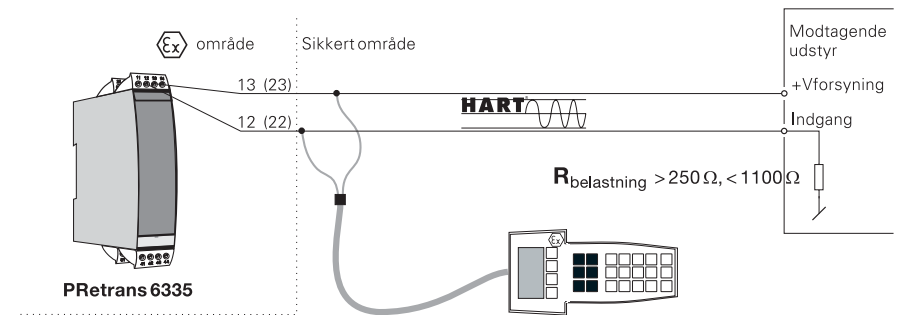

Forbindelse af transmittere i multidrop:

- HART[®]-kommunikatoren eller PC-modem kan tilsluttes over punkterne AB eller BC.
- Udgangene på op til 15 kanaler kan parallelforbindes for digital HART[®]-kommunikation på 2-ledere.
- Hver transmitter skal, inden den tilsluttes, konfigureres med et unikt nummer fra 1 - 15. Hvis 2 transmittere konfigureres med samme nummer, ses der bort fra begge. Transmitterne skal programmeres til multidrop mode (med et fast udgangssignal på 4 mA). Den maksimale strøm i sløjfen kan dermed blive 60 mA.
- Kommunikationen kan foregå via HART[®]-kommunikator eller HART[®]-modem.
- PRreset PC konfigurationssoftwaren kan konfigurere den enkelte transmitter til multidrop mode og tildele en unik polling adresse.

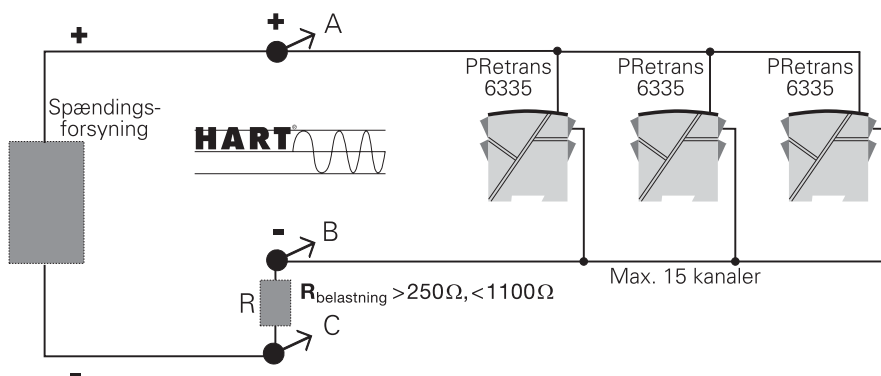

2-WIRE HART[®] TRANSMITTER

PRetrans 6335

Contents

Safety instructions.....	18
Declaration of Conformity	19
Application	20
Technical characteristics	20
Mounting / installation.....	20
Applications.....	21
Order	22
Electrical specifications.....	22
Connections	26
Block diagram	28
Programming	29
Loop Link.....	29
HART [®] modem	30
HART [®] communicator	31
Connection of transmitters in multidrop mode.....	32
Appendix:	
FM Installation Drawing No. 6335QF01	66
CSA Installation Drawing No. 6335QC02	68

Safety instructions

Ex installation:

For a safe installation of 6335B in hazardous area the following must be observed. The module must only be installed by qualified personnel who are familiar with the national and international laws, directives and standards that apply to this area.

Year of manufacture can be taken from the first two digits in the serial number.

Repair:

Repair of the module must be done by PR electronics A/S only.

DECLARATION OF CONFORMITY

As manufacturer

PR electronics A/S

Lerbakken 10

DK-8410 Rønde

hereby declares that the following product:

Type: 6335

Name: 2-wire HART® transmitter

is in conformity with the following directives and standards:

EMC directive 2004/108/EC and later amendments

EN 61326

This declaration is issued in compliance with article 10, subclause 1 of the EMC directive. For specification of the acceptable EMC performance level, refer to the electrical specifications for the module.

The ATEX directive 94/9/EC and later amendments

EN 50014 and EN 50020

ATEX certificate: 99ATEX126961

Notified body for CENELEC/ATEX: **UL International Demko A/S 0539**

Rønde, 22 Dec. 2005



Peter Rasmussen
Manufacturer's signature

2-WIRE HART® TRANSMITTER PRetrans 6335

- *RTD, TC, Ohm, or mV input*
- *Extremely high measurement accuracy*
- *HART® communication*
- *Galvanic isolation*
- *1- or 2-channel version*

Application:

- Linearised temperature measurement with Pt100...Pt1000, Ni100...Ni1000 TC or sensor.
- Difference or average temperature measurement of 2 resistance or TC sensors.
- Conversion of linear resistance variation to a standard analogue current signal, for instance from valves or Ohmic level sensors.
- Amplification of a bipolar mV signal to a standard 4...20 mA current signal.
- Connection of up to 15 channels to a digital 2-wire signal with HART® communication.

Technical characteristics:

- Within a few seconds the user can program PR6335 to measure temperatures within all ranges defined by the norms.
- The RTD and resistance inputs have cable compensation for 2-, 3- and 4-wire connection.
- A limit can be programmed on the output signal.
- Continuous check of vital stored data for safety reasons.
- Sensor error detection according to the guidelines in NAMUR NE 89.

Mounting / installation:

- Mounted vertically or horizontally on a DIN rail. As the modules can be mounted without any distance between neighbouring units, up to 84 channels can be mounted per metre.
- **NB:** As Ex barrier for 6335B we recommend 5106B.

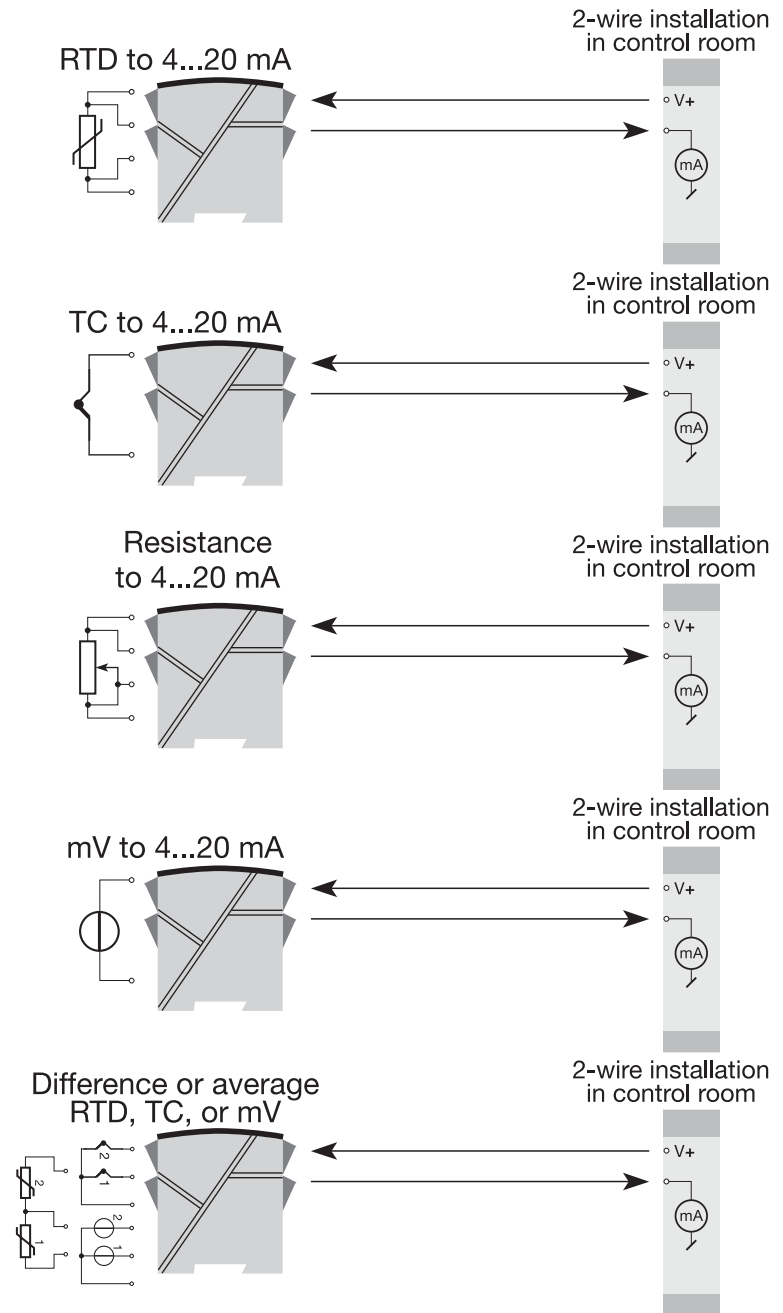

Order: 6335

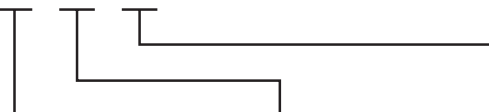

Type	Version	Galvanic isolation	Channels
6335	Standard : A	1500 VAC : 2	Single : A
	ATEX : B		Double : B
	FM and ATEX : C		
	CSA, FM and ATEX : D		

*NB! Please remember to order CJC connectors type 5910/5910EEx (channel 1) and 5913/5913EEx (channel 2) for TC inputs with an internal CJC.

Electrical specifications:

Specifications range:

-40°C to +60°C

Common specifications:

Supply voltage, DC

Standard 8.0...35 VDC

ATEX, FM and CSA, 6335B, C and D.. 8.0...28 VDC

Isolation voltage, test / operation 1.5 kVAC / 50 VAC

Isolation voltage, channel 1 / channel 2:

Standard, 6335A 3.75 kVAC

ATEX, FM and CSA, 6335B, C and D.. 1500 VAC

Warm-up time..... 30 s

Communications interface Loop Link and HART®

Signal / noise ratio Min. 60 dB

Response time (programmable)..... 1...60 s

EEPROM error check < 10 s

Signal dynamics, input..... 22 bit

Signal dynamics, output 16 bit

Calibration temperature 20...28°C

Accuracy, the greater of general and basic values:

General values		
Input type	Absolute accuracy	Temperature coefficient
All	≤ ±0.05% of span	≤ ±0.005% of span / °C

Basic values		
Input type	Basic accuracy	Temperature coefficient
Pt100 and Pt1000	≤ ±0.1°C	≤ ±0.005°C/°C
Ni100	≤ ±0.2°C	≤ ±0.005°C/°C
Lin. R	≤ ±0.1 Ω	≤ ±5 mΩ/°C
Volt	≤ ±10 μV	≤ ±0.5 μV/°C
TC type: E, J, K, L, N, T, U	≤ ±0,5°C	≤ ±0.025°C/°C
TC type: B, R, S, W3, W5	≤ ±1°C	≤ ±0.1°C/°C

EMC immunity influence	< ±0.1% of span
Extended EMC immunity: NAMUR NE 21, A criterion, burst	< ±1% of span

Effect of supply voltage variation..... < 0.005% of span / VDC

Max. wire size..... 1 x 1.5 mm² stranded wire

Humidity < 95% RH (non-cond.)

Dimensions..... 109 x 23.5 x 104 mm

Tightness (enclosure / terminals) IP50 / IP20

Weigh (1 / 2 channels)..... 145 / 185 g

Electrical specifications, inputs:

Max. offset 50% of selected numerical max. value

RTD and linear resistance inputs:

RTD type	Min. value	Max. value	Min. span
Pt100	-200°C	+850°C	10°C
Ni100	-60°C	+250°C	10°C
Lin. R	0 Ω	7000 Ω	25 Ω

Cable resistance per wire (max.)..... 5 Ω
 Sensor current..... Nom. 0.2 mA
 Effect of sensor cable resistance
 (3- / 4-wire)..... < 0.002 Ω / Ω
 Sensor error detection Yes
 Short circuit detection..... If 0% > 30 Ω

TC inputs:

Type	Min. temperature	Max. temperature	Min. span	Norm
B	+400°C	+1820°C	100°C	IEC584
E	-100°C	+1000°C	50°C	IEC584
J	-100°C	+1200°C	50°C	IEC584
K	-180°C	+1372°C	50°C	IEC584
L	-100°C	+900°C	50°C	DIN 43710
N	-180°C	+1300°C	50°C	IEC584
R	-50°C	+1760°C	100°C	IEC584
S	-50°C	+1760°C	100°C	IEC584
T	-200°C	+400°C	50°C	IEC584
U	-200°C	+600°C	50°C	DIN 43710
W3	0°C	+2300°C	100°C	ASTM E988-90
W5	0°C	+2300°C	100°C	ASTM E988-90

Cold junction compensation < ±1.0°C
 External CJC with Ni100 or Pt100 -40 ≤ T_{amb.} ≤ 135°C
 Sensor error detection Yes
 Sensor error current:
 When detecting..... Nom. 33 µA
 Else 0 µA
 Short circuit detection..... If 0% > 5 mV

Voltage inputs:

Measurement range -800...+800 mV
 Min. span..... 2.5 mV
 Input resistance..... 10 MΩ

Current output:

Signal range 4...20 mA
 Min. signal range..... 16 mA
 Updating time..... 440 ms
 (660 ms for diff.)
 Fixed output signal..... Between 4 and 20 mA
 Output signal at EEprom error ≤ 3.5 mA
 Load resistance..... ≤ (V_{supply} - 8) / 0.023 [Ω]
 Load stability < ±0.01% of span / 100 Ω

Sensor error detection:

Programmable..... 3.5...23 mA
 NAMUR NE43 Upscale 23 mA
 NAMUR NE43 Downscale..... 3.5 mA

Ex / I.S. data:

Output, terminal 11...14, (21...24):
 U_i : 28 VDC
 I_i : 120 mADC
 P_i : 0.84 W
 L_i : 10 µH
 C_i : 1.0 nF
 Input, terminal 41...44, (51...54):
 U_o : 9.6 VDC
 I_o : 28 mADC
 P_o : 67.2 mW
 L_o : 35 mH
 C_o : 3.5 µF

EEx / I.S. approval:

DEMKO 99ATEX126961  II 1 G
 EEx ia IIC T1...T6
 Max. amb. temperature for T1...T6 60°C
 ATEX, applicable in zone..... 0, 1 or 2
 FM, applicable in..... IS, Class I, Div. 1, Group A, B, C, D
 IS, Class I, Zone 0, AEx ia IIC
 Entity, FM Installation Drawing No. 6335QF01
 CSA, applicable in..... IS, Class I, Div. 1, Group A, B, C, D,
 Ex ia IIC
 IS, Class I, Zone 0, AEx ia IIC
 Installation Drawing No. 6335QC02

GOST R approval:

Standard: VNIIM Cert. no. Ross DK.ME48.V01899
 Ex: VNIIFTRI Cert. no. Ross DK.GB06.V00100

Observed authority requirements:

Standard:
 EMC 2004/108/EC
 Emission and immunity EN 61326
 ATEX 94/9/EC EN 50014 and EN 50020
 FM, ASCN 3600, 3611, 3610
 CSA, CAN / CSA C22.2 No. 157, E60079-11, UL 913

Of span = Of the presently selected range

Connections:

Inputs:

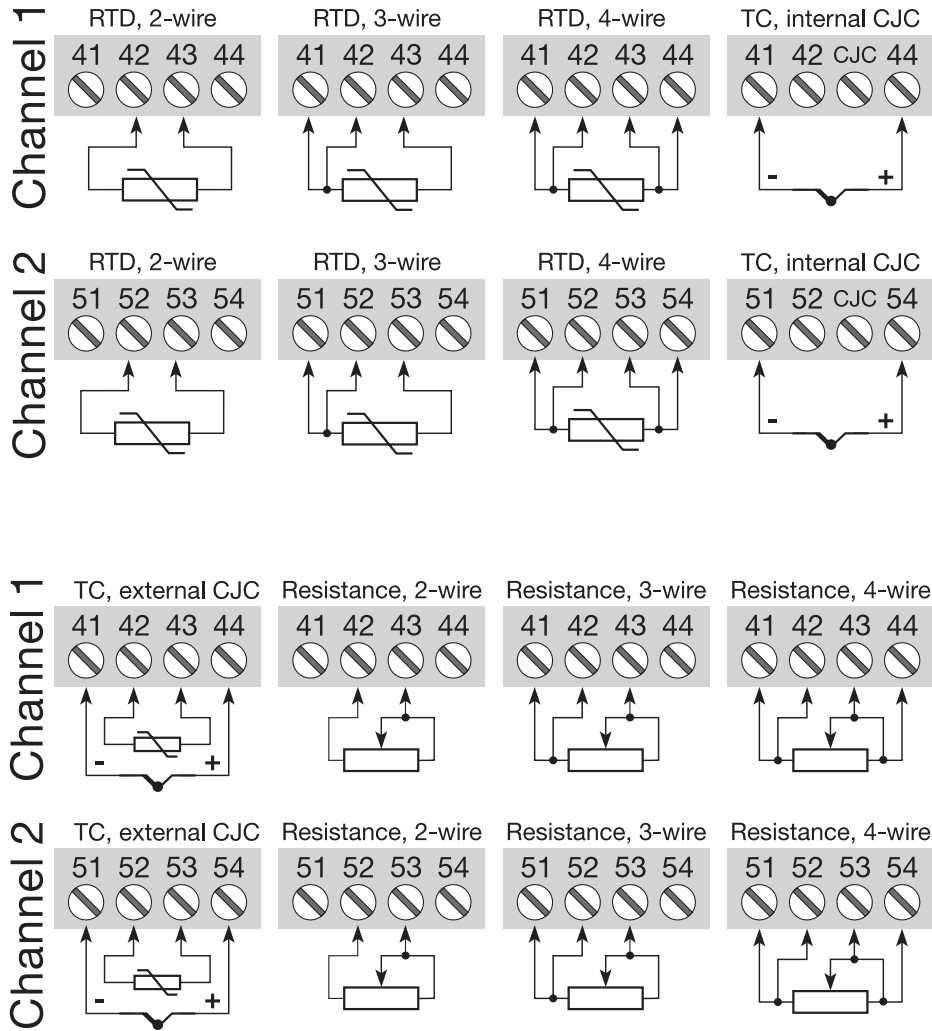

Connections:

Inputs:

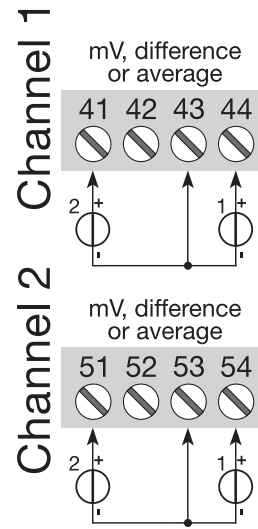
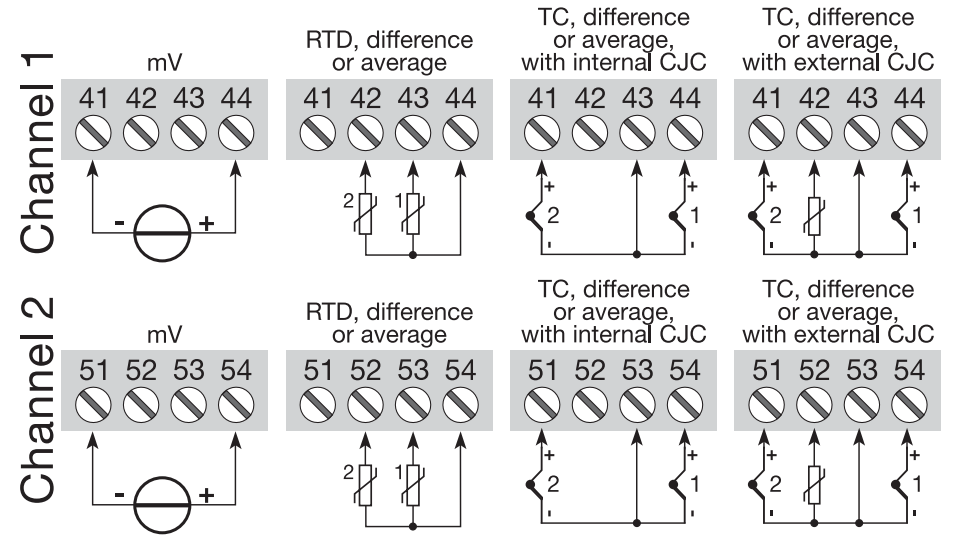

Outputs:

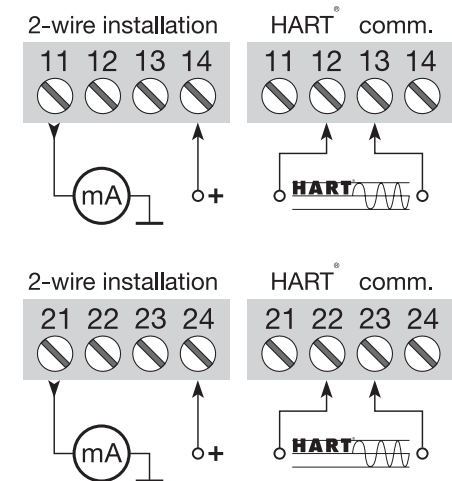

BLOCK DIAGRAM:

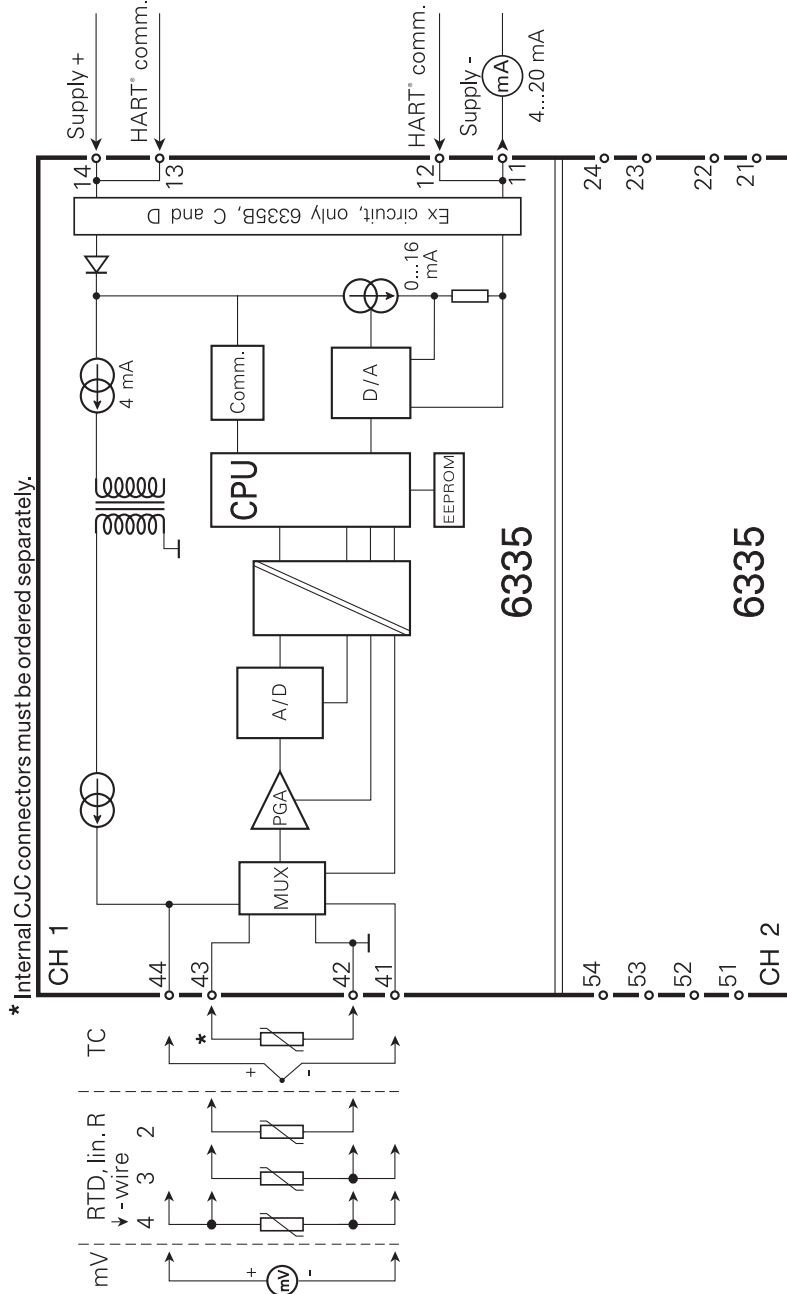

Programming:

PRetrans 6335 can be configured in the following 3 ways:

1. With PR electronics A/S' communications interface Loop Link and PReset PC configuration software.
2. With a HART® modem and PReset PC configuration software.
3. With a HART® communicator with PR electronics A/S' DDL driver.

1: Loop Link:

For programming please refer to the drawing below and the help functions in PReset.

- When communicating with non-installed modules, connectors 11, 12, 13, 14 (channel 1) and 21, 22, 23, 24 (channel 2) can be dismantled in the safe area to connect the terminals of the communications interface to the pins. Loop Link is not approved for communication with modules installed in hazardous (Ex) area.

Order: Loop Link

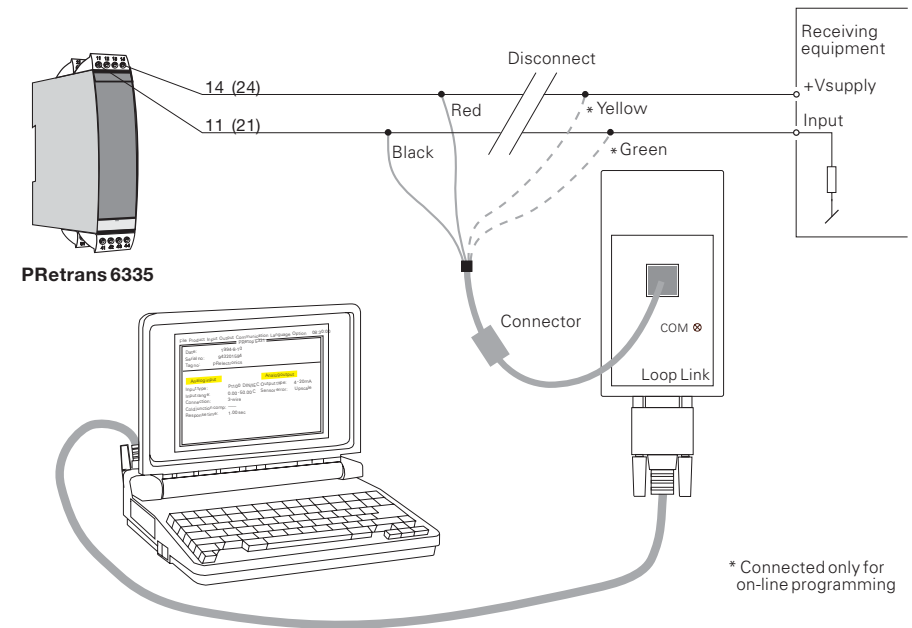

2: HART® modem:

For programming please refer to the drawing below and the help functions in PReset.

Order: HART® modem 276D

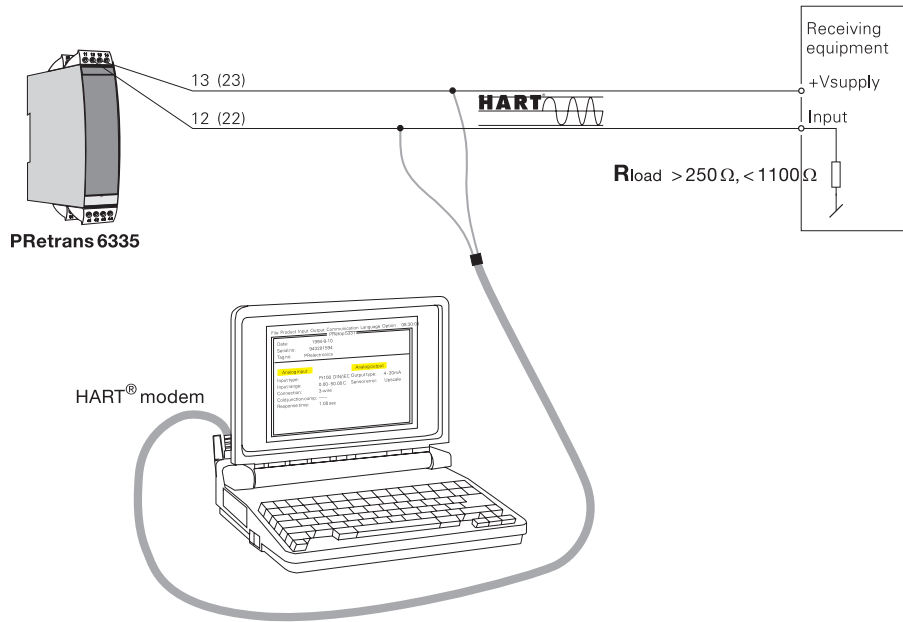

3: HART® communicator:

For programming please refer to the drawing below. To get access to product-specific commands, the HART® communicator must be loaded with the PR electronics A/S DDL driver. This can be ordered either at the HART® Communication Foundation or PR electronics A/S.

Order: HART® communicator 275D

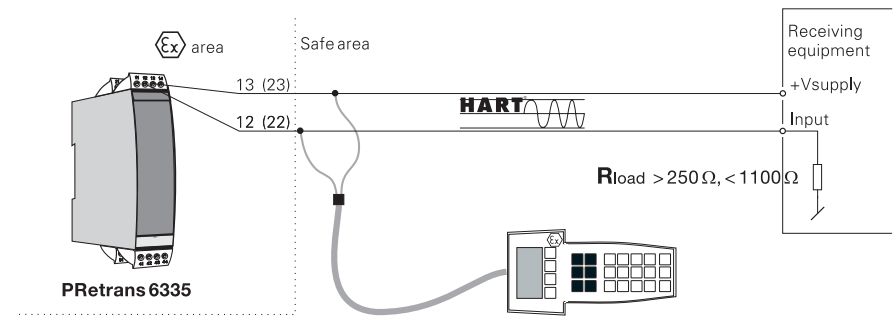

Connection of transmitters in multidrop mode:

- The HART® communicator or a PC modem can be connected across AB or BC.
- The outputs of max. 15 transmitters can be connected in parallel for a digital HART® communication on 2-wires.
- Before it is connected, each transmitter must be configured with a unique number from 1 to 15. If 2 transmitters are configured with the same number, both will be excluded. The transmitters must be programmed for multidrop mode (with a fixed output signal of 4 mA). Maximum current in the loop is therefore 60 mA.
- The communication is either by means of a HART® communicator or a HART® modem.
- The PReset PC configuration software can configure the individual transmitter for multidrop mode and provide it with a unique polling address.

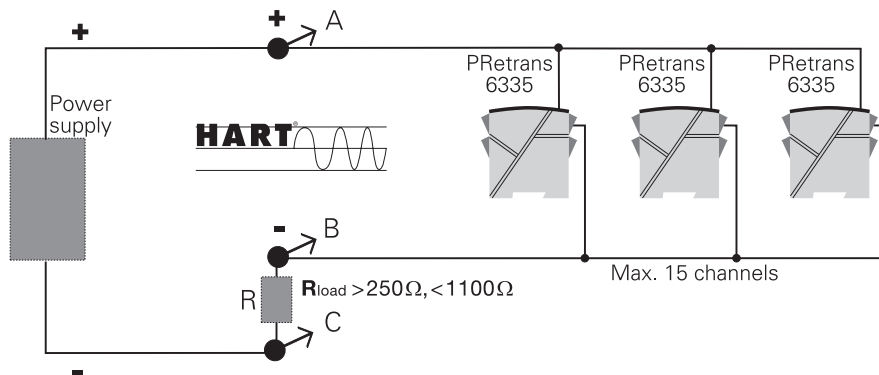

TRANSMETTEUR 2-FILS AVEC PROTOCOLE HART®

PRetrans 6335

Sommaire

Consigne de sécurité	34
Déclaration de conformité.....	35
Application	36
Caractéristiques techniques	36
Montage / installation.....	36
Applications.....	37
Référence	38
Spécifications électriques	38
Connexions	42
Schéma de principe	44
Programmation.....	45
Loop Link.....	45
Modem HART®	46
Communicateur HART®	47
Raccordement des transmetteurs en multi-adressage.....	48
Appendix:	
FM Installation Drawing No. 6335QF01	66
CSA Installation Drawing No. 6335QC02	68

Consigne de sécurité

Installation S.I. :

Pour l'installation de 6335B dans les zones dangereuses, conformez-vous aux consignes de sécurité suivantes : l'installation ne doit être réalisée que par du personnel qualifié connaissant la législation nationale et internationale ainsi que les directives et standards régissant ce domaine.

L'année de production ressort des deux premiers chiffres du numéro de série.

Réparation :

Seule PR electronics SARL est autorisée à réparer le module.

DECLARATION DE CONFORMITE

En tant que fabricant

PR electronics A/S

Lerbakken 10

DK-8410 Rønde

déclare que le produit suivant :

Type : 6335

Nom : Transmetteur 2-fils avec protocole HART®

correspond aux directives et normes suivantes :

La directive CEM (EMC) 2004/108/CE et les modifications subséquentes

EN 61326

Cette déclaration est délivrée en correspondance à l'article 10, alinéa 1 de la directive CEM. Pour une spécification du niveau de rendement acceptable CEM (EMC) renvoyer aux spécifications électriques du module.

La directive ATEX 94/9/CE et les modifications subséquentes

EN 50014 et EN 50020

Certificat Ex : 99ATEX126961

Organisme notifié pour CENELEC/ATEX : **UL International Demko A/S 0539**

Rønde, le 22 decembre 2005



Peter Rasmussen
Signature du fabricant

TRANSMETTEUR 2-FILS AVEC PROTOCOLE HART® PRetrans 6335

- *Entrée RTD, TC, résistance ou mV*
- *Très grande précision de mesure*
- *Communication avec protocole HART®*
- *Isolation galvanique*
- *Version 1- ou 2-voies*

Application :

- Mesure linéarisée de la température avec un capteur Pt100...Pt1000, Ni100...Ni1000 ou de thermocouples.
- Mesure de la température différentielle ou moyenne avec 2 sondes résistives ou thermocouples.
- Conversion d'une résistance linéaire en un signal courant standard analogique pour mesurer par exemple le niveau ou la position d'une vanne.
- Amplification d'un signal mV bipolaire en un signal courant standard de 4...20 mA.
- Connexion en parallèle de 15 transmetteurs au maximum pour une communication digitale avec le protocole HART®.

Caractéristiques techniques :

- Le PR6335 peut être programmé de manière simple et rapide.
- Compensation de ligne pour des entrées RTD et résistance avec un raccordement à 2, 3 et 4 fils.
- Le signal de sortie peut être programmé avec un limite.
- Vérification continue des données sauvegardés.
- Détection de rupture sonde selon les recommandations NAMUR NE 89.

Montage / installation :

- Pour montage vertical ou horizontal sur rail DIN. En version 2-voies, 84 voies par mètre peuvent être montées.
- **N.B. :** Comme barrière S.I. pour le 6335B nous recommandons le PR5106B.

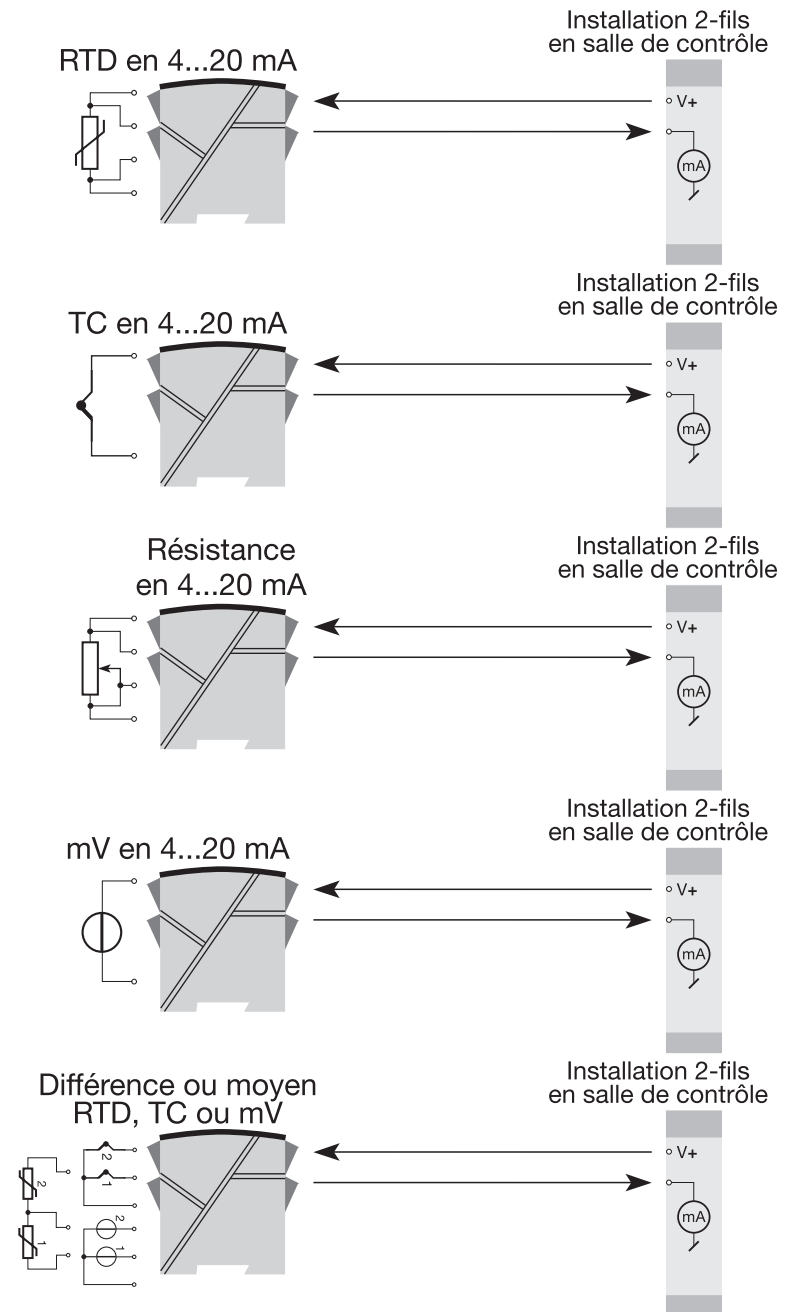

Référence : 6335

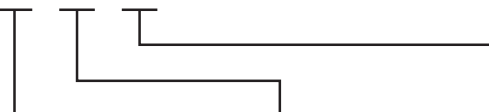

Type	Version	Isolation galvanique	Voies
6335	Standard : A	1500 Vca : 2	Une : A
	ATEX : B		Deux : B
	FM et ATEX : C		
	CSA, FM et ATEX : D		

*NB! Pour des entrées à TC interne, rappelez-vous de commander le(s) bornier(s) réf. PR5910 / PR5910EEEx (voie 1) et PR5913 / PR5913EEEx (voie 2).

Spécifications électriques :

Plage des spécifications :

-40°C à +60°C

Spécifications communes :

Tension d'alimentation cc

Standard 8,0...35 Vcc

ATEX, FM et CSA, 6335B, C et D..... 8,0...28 Vcc

Tension d'isolation, test / opération..... 1,5 kVca / 50 Vca

Tension d'isolation, voie 1 / voie 2 :

Standard, 6335A 3,75 kVca

ATEX, FM et CSA, 6335B, C et D..... 1500 Vca

Temps de chauffe..... 30 s

Kit de programmation Loop Link et HART®

Rapport signal / bruit Min. 60 dB

Temps de réponse (programmable) 1...60 s

Vérification de l'EEPROM..... < 10 s

Dynamique du signal d'entrée 22 bit

Dynamique du signal de sortie 16 bit

Température d'étalonnage 20...28°C

Précision, la plus grande des valeurs générales et de base :

Valeurs générales		
Type d'entrée	Précision absolue	Coefficient de température
Tous	≤ ±0,05% de l'EC	≤ ±0,005% de l'EC / °C

Valeurs de base		
Type d'entrée	Précision de base	Coefficient de température
Pt100 et Pt1000	≤ ±0,1°C	≤ ±0,005°C/°C
Ni100	≤ ±0,2°C	≤ ±0,005°C/°C
R. lin.	≤ ±0,1 Ω	≤ ±5 mΩ/°C
Volt	≤ ±10 μV	≤ ±0,5 μV/°C
Type TC : E, J, K, L, N, T, U	≤ ±0,5°C	≤ ±0,025°C/°C
Type TC : B, R, S, W3, W5	≤ ±1°C	≤ ±0,1°C/°C

Immunité CEM.....	< ±0,1% de l'EC
Immunité CEM améliorée :	
NAMUR NE 21, critère A, burst	< ±1% de l'EC

Effet d'une variation

de la tension d'alimentation < 0,005% de l'EC / Vcc

Taille max. des fils 1 x 1,5 mm² fil multibrins

Humidité < 95% HR (sans cond.)

Dimensions..... 109 x 23,5 x 104 mm

Étanchéité (boîtier / bornier)..... IP50 / IP20

Poids (1 / 2 voies)..... 145 / 185 g

Spécifications électriques, entrées :

Décalage max. 50% de la valeur numérique max. sélectionnée

Entrée RTD et entrée résistance linéaire :

Type RTD	Valeur min.	Valeur max.	Plage min.
Pt100	-200°C	+850°C	10°C
Ni100	-60°C	+250°C	10°C
R. lin.	0 Ω	7000 Ω	25 Ω

Résistance de ligne max. par fil..... 5 Ω
 Courant de sonde Nom. 0,2 mA
 Effet de la résistance de ligne (3- / 4-fils) ... < 0,002 Ω / Ω
 Détection de rupture sonde Oui
 Détection de court-circuit Si 0% > 30 Ω

Entrées TC :

Type	Température min.	Température max.	Plage min.	Norme
B	+400°C	+1820°C	100°C	IEC584
E	-100°C	+1000°C	50°C	IEC584
J	-100°C	+1200°C	50°C	IEC584
K	-180°C	+1372°C	50°C	IEC584
L	-100°C	+900°C	50°C	DIN 43710
N	-180°C	+1300°C	50°C	IEC584
R	-50°C	+1760°C	100°C	IEC584
S	-50°C	+1760°C	100°C	IEC584
T	-200°C	+400°C	50°C	IEC584
U	-200°C	+600°C	50°C	DIN 43710
W3	0°C	+2300°C	100°C	ASTM E988-90
W5	0°C	+2300°C	100°C	ASTM E988-90

Compensation de soudure froide < ±1,0°C
 CSF externe avec Ni100 ou Pt100 -40 ≤ T_{amb.} ≤ 135°C
 Détection de rupture sonde Oui
 Courant de sonde :
 Pendant la détection..... Nom. 33 µA
 Si non..... 0 µA
 Détection de court-circuit Si 0% > 5 mV

Entrées tension :

Gamme de mesure..... -800...+800 mV
 Plage de mesure min. 2,5 mV
 Résistance d'entrée 10 MΩ

Sorties courant :

Gamme de mesure..... 4...20 mA
 Plage de mesure min. 16 mA
 Temps de scrutation..... 440 ms
 (660 ms pour diff.)
 Signal sortie fixe..... Entre 4 et 20 mA
 Sortie en cas de corruption de l'EEPROM.... ≤ 3,5 mA
 Résistance de charge..... ≤ (V_{alim.} - 8) / 0,023 [Ω]
 Stabilité de charge..... < ±0,01% de l'EC / 100 Ω

Détection de rupture de sonde :

Programmable..... 3,5...23 mA
 NAMUR NE43 Haut d'échelle 23 mA
 NAMUR NE43 Bas d'échelle..... 3,5 mA

Caractéristiques S.I. :

Sortie, borne 11...14, (21...24) :
 U_i : 28 Vcc
 I_i : 120 mAcc
 P_i : 0,84 W
 L_i : 10 µH
 C_i : 1,0 nF
 Entrée, borne 41...44, (51...54) :
 U_o : 9,6 Vcc
 I_o : 28 mAcc
 P_o : 67,2 mW
 L_o : 35 mH
 C_o : 3,5 µF

Approbation EEx / S.I. :

DEMKO 99ATEX126961  II 1 G
 EEx ia IIC T1...T6
 Température amb. max. (T1...T6) 60°C
 ATEX, applicable en zone..... 0, 1 ou 2
 FM, applicable en..... IS, Class I, Div. 1, Group A, B, C, D
 IS, Class I, Zone 0, AEx ia IIC
 Entity, FM Installation Drawing No. 6335QF01
 CSA, applicable en..... IS, Class I, Div. 1, Group A, B, C, D,
 Ex ia IIC
 IS, Class I, Zone 0, AEx ia IIC
 Installation Drawing No. 6335QC02

Approbation GOST R :

Standard : VNIIM..... Cert. no. Ross DK.ME48.V01899
 S.I. : VNIIFTRI..... Cert. no. Ross DK.GB06.V00100

Agrements et homologations :

Standard :
 EMC 2004/108/CE
 Emission et immunité EN 61326
 ATEX 94/9/CE..... EN 50014 et EN 50020
 FM, ASCN 3600, 3611, 3610
 CSA, CAN / CSA C22.2 No. 157, E60079-11, UL 913

EC = Echelle configurée

Connexions :

Entrées :

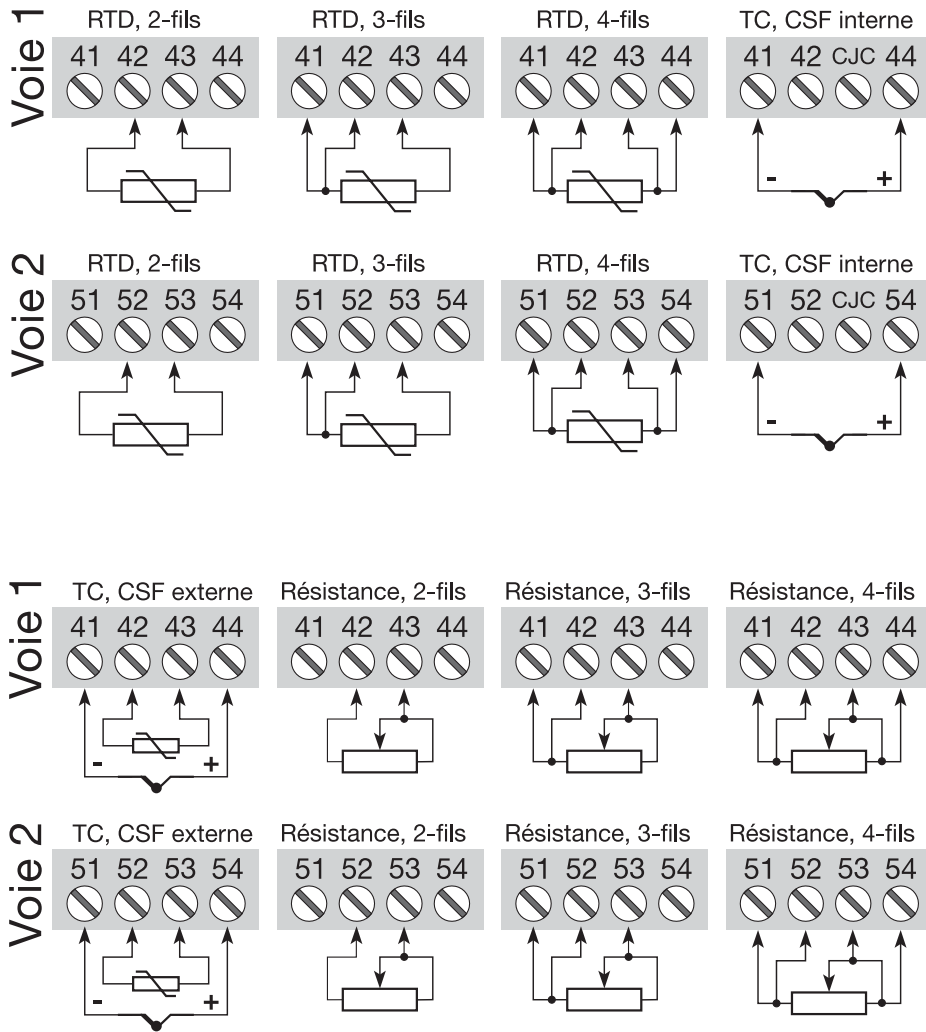

Connexions :

Entrées :

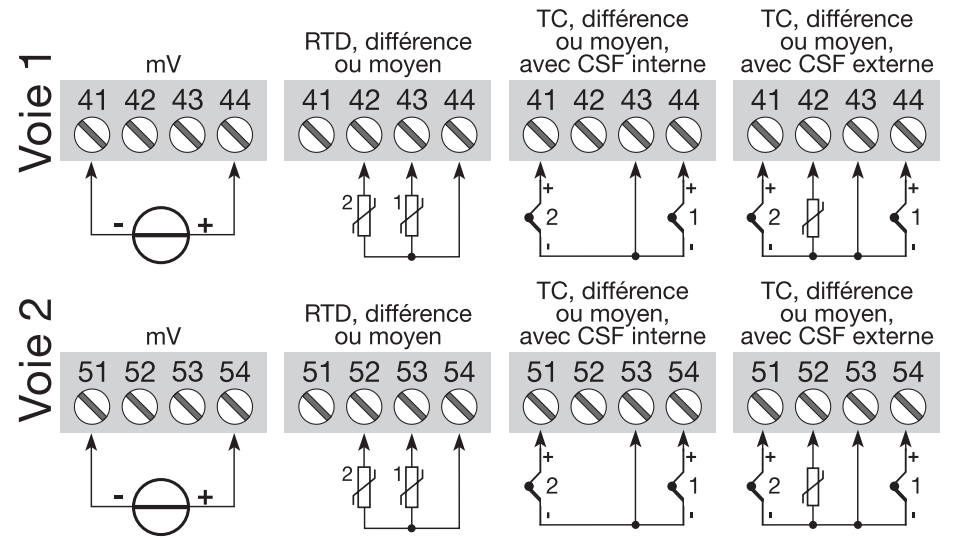

Sorties :

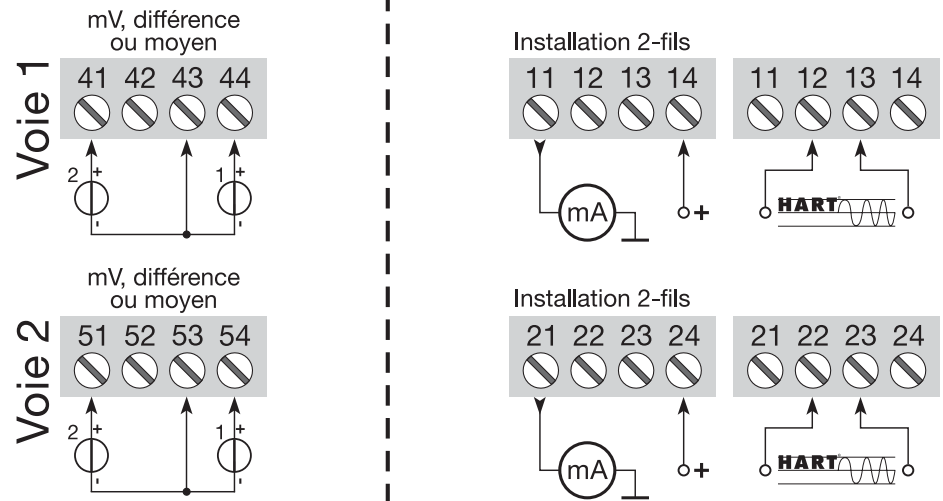

SCHEMA DE PRINCIPE :

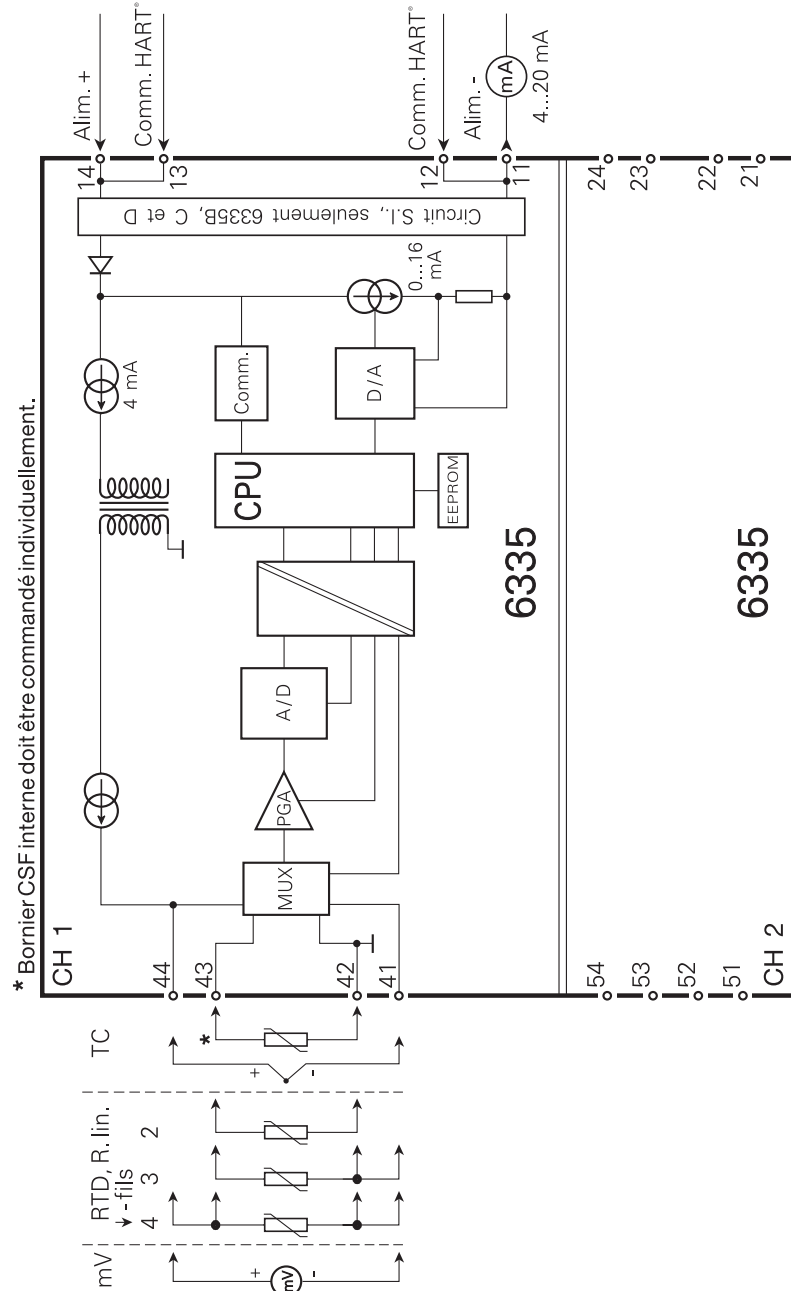

Programmation :

Le PRetrans 6335 peut être programmé des 3 manières suivantes :

1. Avec le kit de programmation Loop Link et le logiciel PReset de PR electronics A/S.
2. Avec le modem HART® et le logiciel PReset.
3. Avec le communicateur HART® chargé avec le DDL de PR electronics A/S.

1 : Loop Link :

Pour le raccordement du Loop Link, veuillez vous reporter au schéma ci-dessous et à l'aide en ligne du logiciel PReset.

- Lors de la communication avec des modules non-installés, les bornes 11, 12, 13, 14 (voie 1) et 21, 22, 23, 24 (voie 2) peuvent être démontés dans la zone non dangereuse pour connecter le kit de programmation. Loop Link ne doit pas être utilisé pour communication avec des modules installés en zone dangereuse.

Référence : Loop Link

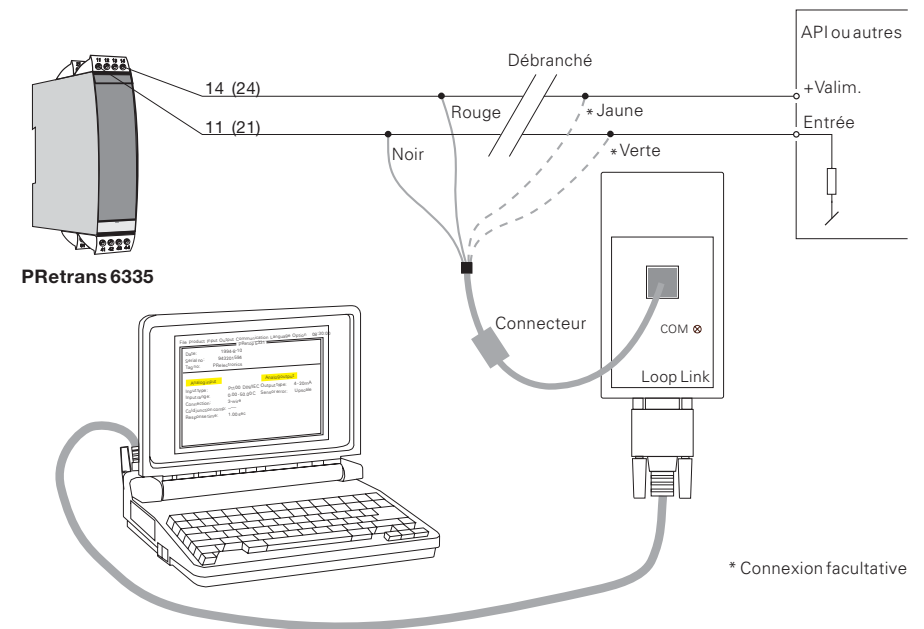

2 : Modem HART® :

Pour le raccordement veuillez vous reporter au schéma ci-dessous et à l'aide en ligne du logiciel PRreset.

Référence : Modem HART® 276D

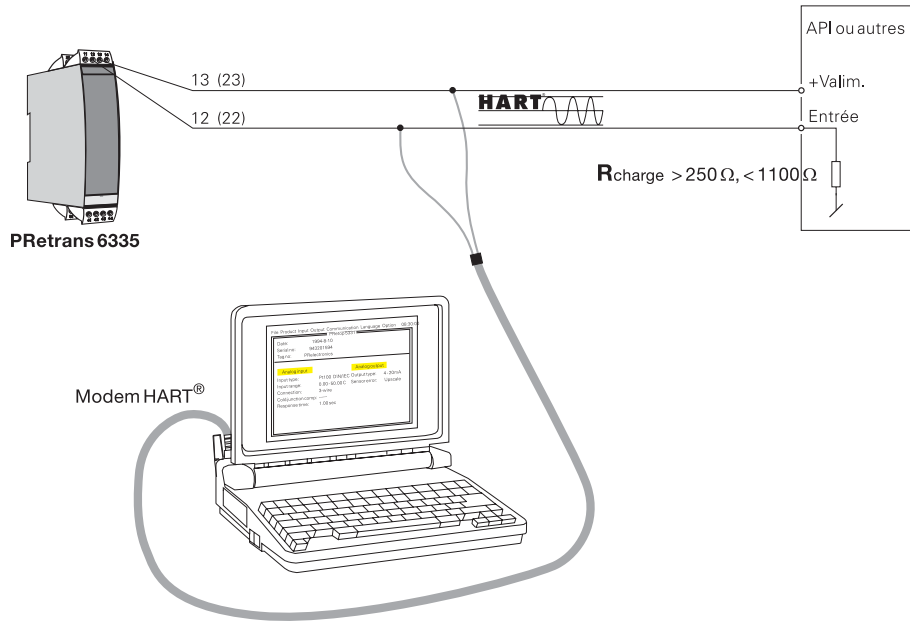

3 : Communicateur HART® :

Pour le raccordement veuillez vous reporter au schéma ci-dessous. Pour avoir accès à tous les paramètres, le communicateur HART® doit être chargé avec le DDL spécifique du PR electronics A/S. Ce DDL peut être commandé chez PR electronics A/S ou chez la Fondation HART®.

Référence : Communicateur HART® 275D

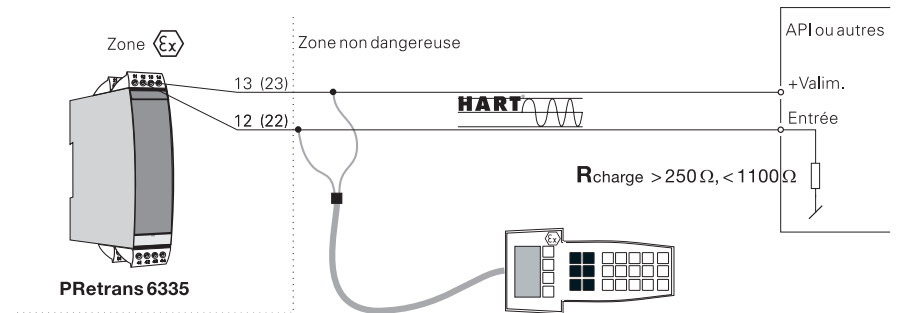

Raccordement des transmetteurs en multi-addressage :

- Le communicateur HART® ou le modem peuvent être connectés sur les points AB ou sur les points BC.
- Pour la communication digitale HART® de 2-fils, les sorties de 15 transmetteurs au maximum peuvent être connectés en parallèle.
- Chaque transmetteur sera doté d'un numéro unique entre 1 et 15. Si 2 transmetteurs ont le même numéro, tous les deux seront ignorés. Programmés pour multi-addressage les sorties des transmetteurs seront bloquées à 4 mA, et le courant max. dans la boucle sera donc de 60 mA.
- La communication se fait ensuite soit avec le communicateur HART® soit avec le modem HART®.
- Le logiciel PReset peut configurer le transmetteur individuel en multi-addressage et lui donner un adressage unique.

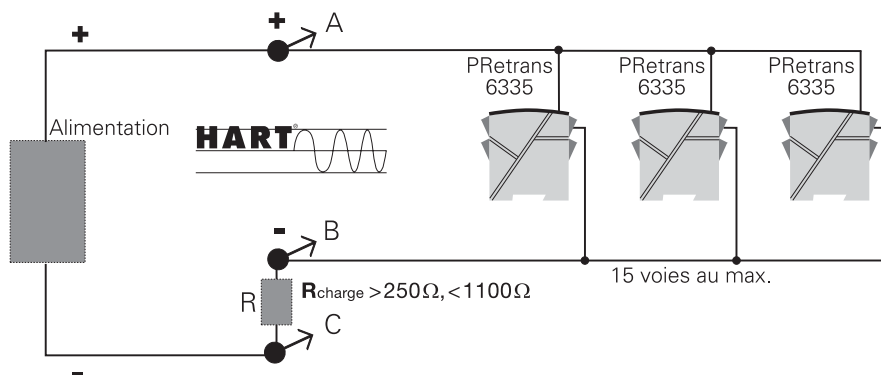

2-DRAHT MESSUMFORMER MIT HART® PROTOKOLL

PRetrans 6335

Inhaltsverzeichnis

Sicherheitsanweisung	50
Konformitätserklärung	51
Verwendung.....	52
Technische Merkmale.....	52
Montage / Installation.....	52
Anwendungen	53
Bestellangaben.....	54
Elektrische Daten	54
Anschlüsse	58
Blockdiagramm	60
Programmierung.....	61
Loop Link.....	61
HART® Modem	62
HART® Kommunikator.....	63
Parallelanschluss von Signalgebern (Multidrop)	64
Appendix:	
FM Installation Drawing No. 6335QF01	66
CSA Installation Drawing No. 6335QC02	68

Sicherheitsanweisung

Ex Installation:

Für sichere Installation von 6335B in explosionsgefährdeter Umgebung muss folgendes beobachtet werden. Die Installation muss nur von qualifizierten Personen, die mit den nationalen und internationalen Gesetze, Direktiven und Standards des Gebiets bekannt sind, vorgenommen werden.

Die ersten beiden Ziffern der Seriennummer geben das Produktionsjahr an.

Reparatur:

Reparatur des Moduls muss nur von PR electronics A/S vorgenommen werden.

KONFORMITÄTSERKLÄRUNG

Als Hersteller bescheinigt

PR electronics A/S

Lerbakken 10

DK-8410 Rønde

hiermit für das folgende Produkt:

Typ: 6335

Name: 2-Draht Messumformer mit HART® Protokoll

die Konformität mit folgenden Richtlinien und Normen:

EMV Richtlinien 2004/108/EG und nachfolgende Änderungen

EN 61326

Diese Erklärung ist in Übereinstimmung mit Artikel 10, Unterklausel 1 der EMV Richtlinie ausgestellt. Zur Spezifikation des zulässigen Erfüllungsgrades, siehe die Elektrische Daten des Moduls.

Die ATEX Richtlinien 94/9/EG und nachfolgende Änderungen

EN 50014 und EN 50020

ATEX-Zertifikat: 99ATEX126961

Zulassungsstelle für CENELEC/ATEX: **UL International Demko A/S 0539**

Rønde, 22. Dez. 2005



Peter Rasmussen
Unterschrift des Herstellers

2-DRAHT MESSUMFORMER MIT HART[®]-PROTOKOLL PRetrans 6335

- Eingang für WTH, TE, Ω oder mV
- Extreme Messgenauigkeit
- HART[®]-Kommunikation
- Galvanische Trennung
- 1- oder 2-kanalige Ausführung

Verwendung:

- Linearisierte Temperaturmessung mit Pt100...Pt1000, Ni100...Ni1000 oder Thermoelementsensoren.
- Temperaturdifferenzen oder eine Durchschnittstemperaturmessung von 2 Widerstands- oder TE-Sensoren.
- Umwandlung von linearer Widerstandsänderung in ein analoges Standard-Stromsignal, z.B. von Ventilen oder Niveau-Messwertgeber.
- Verstärkung von bipolaren mV-Signalen zu einem Standard 4...20 mA Stromsignal.
- Bis zu fünfzehn Umformer können in einem Multidrop-System parallel verbunden werden mit HART[®] Kommunikation.

Technische Merkmale:

- PR6335 kann vom Benutzer innerhalb von wenigen Sekunden zur Messung in allen genormten Temperaturbereiche programmiert werden.
- Der WTH- und Widerstandseingang haben Leitungskompensation bei 2-, 3- oder 4-Leiter-Anschluss.
- Das Ausgangssignal kann für eine Begrenzung programmiert werden.
- Die gespeicherten Daten werden laufend kontrolliert.
- Fehlererkennung in Übereinstimmung mit der Richtlinien der NAMUR NE 89.

Montage / Installation:

- Wird vertikal oder horizontal auf DIN-Schiene montiert. Mit der Zweitkanal version können 84 Kanäle pro Meter installiert werden.
- **NB:** Als Ex-Sicherheitsbarriere für 6335B empfehlen wir 5106B.

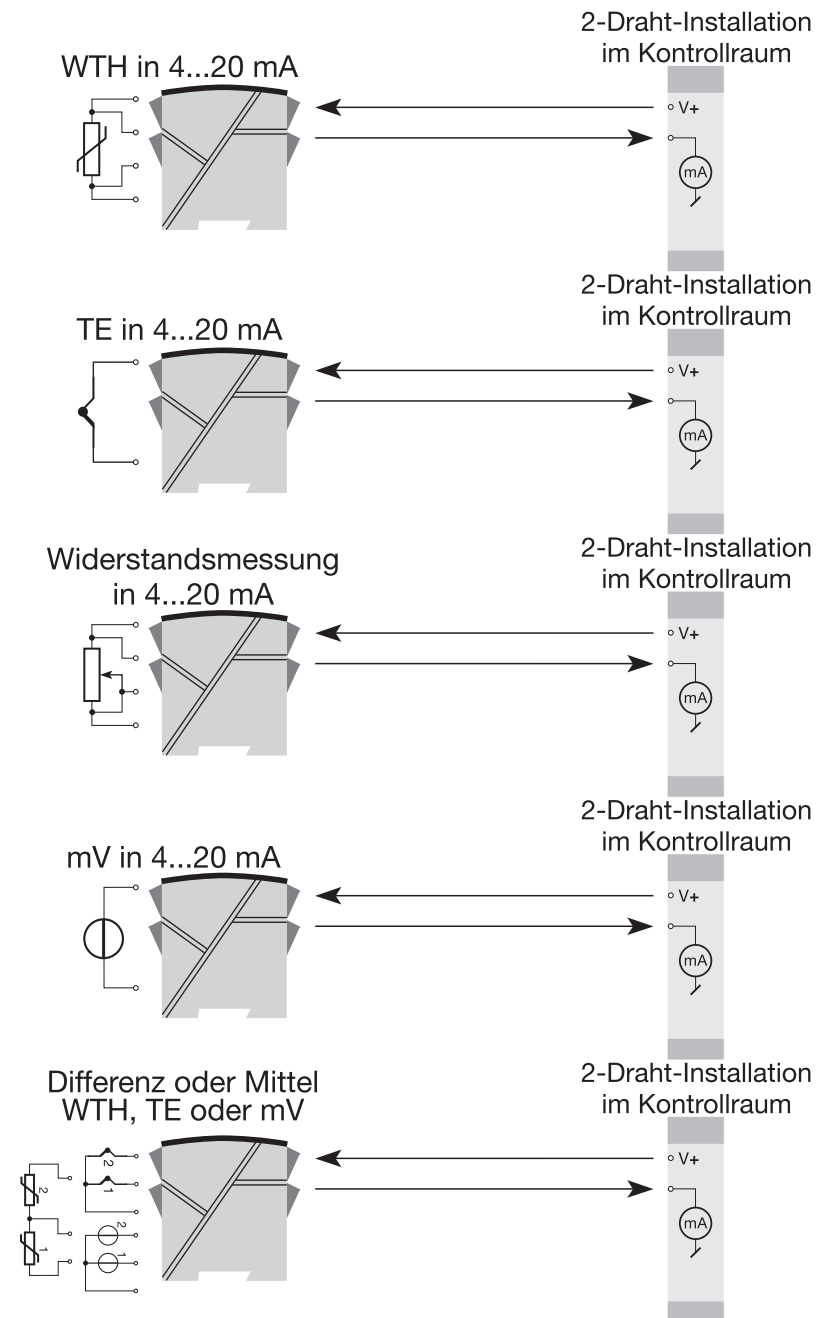

Bestellangaben: 6335

Typ	Version	Galvanische Trennung	Kanäle
6335	Standard : A	1500 VAC : 2	Einfach : A
	ATEX : B		Zweifach : B
	FM und ATEX : C		
	CSA, FM und ATEX : D		

***Zu beachten!** In Verbindung mit TE-Eingänge CJC-Klemme Typ 5910 / 5910EEx (Kanal 1) und 5913 / 5913EEx (Kanal 2) zu bestellen.

Elektrische Daten:

Spezifikationsbereich:

-40°C bis +60°C

Gemeinsame Daten:

Versorgungsspannung, DC

Standard 8,0...35 VDC

ATEX, FM und CSA, 6335B, C und D .. 8,0...28 VDC

Isolationsspannung, Test / Betrieb..... 1,5 kVAC / 50 VAC

Isolationsspannung, Kanal 1 / Kanal 2:

Standard, 6335A..... 3,75 kVAC

ATEX, FM und CSA, 6335B, C und D .. 1500 VAC

Aufwärmzeit..... 30 s

Kommunikationsschnittstelle Loop Link & HART®

Signal- / Rauschverhältnis Min. 60 dB

Ansprechzeit (programmierbar)..... 1...60 s

EEProm Fehlerkontrolle < 10 s

Signalauflösung, Eingang..... 22 bit

Signalauflösung, Ausgang..... 16 bit

Kalibrierungstemperatur..... 20...28°C

Genauigkeit, höherer Wert von allgemeinen und Grundwerten:

Allgemeine Werte		
Eingangsart	Absolute Genauigkeit	Temperaturkoeffizient
Alle	≤ ±0,05% d. Messsp.	≤ ±0,005% d. Messsp./°C

Grundwerte		
Eingangsart	Grund-Genauigkeit	Temperaturkoeffizient
Pt100 und Pt1000	≤ ±0,1°C	≤ ±0,005°C/°C
Ni100	≤ ±0,2°C	≤ ±0,005°C/°C
Lin. R	≤ ±0,1 Ω	≤ ±5 mΩ/°C
Volt	≤ ±10 μV	≤ ±0,5 μV/°C
TE-Typ: E, J, K, L, N, T, U	≤ ±0,5°C	≤ ±0,025°C/°C
TE-Typ: B, R, S, W3, W5	≤ ±1°C	≤ ±0,1°C/°C

EMV-Immunitätseinwirkung.....	< ±0,1% d. Messsp.
Erweiterte EMV Immunität: NAMUR NE 21, A Kriterium Burst.....	< ±1% d. Messsp.

Einfluss von Änderung der

Versorgungsspannung..... 0,005% d. Messsp. / VDC

Max. Leitungsquerschnitt..... 1 x 1,5 mm² Litzendraht

Luftfeuchtigkeit..... < 95% RF (nicht kond.)

Maß (H x B x D)..... 109 x 23,5 x 104 mm

Dichtheit (Gehäuse / Anschluss) IP50 / IP20

Gewicht (1 / 2 Kanäle)..... 145 / 185 g

Elektrische Daten, Eingang:

Max. Nullpunktverschiebung (Offset) 50% des gewählten numerischen Max.-Wertes

WTH- und linearer Widerstandseingang:

WTH-Typ	Min. Wert	Max. Wert	Min. Spanne
Pt100	-200°C	+850°C	10°C
Ni100	-60°C	+250°C	10°C
Lin. R	0 Ω	7000 Ω	25 Ω

Leitungswiderstand pro Leiter (Max.)..... 5 Ω
 Sensorstrom Nom. 0,2 mA
 Wirkung des Leitungswiderstandes
 (3- / 4-Leiter) < 0,002 Ω / Ω
 Fühlerfehlererkennung..... Ja
 Kurzschlusserkennung Falls 0% > 30 Ω

TE-Eingänge:

Typ	Min. Temperatur	Max. Temperatur	Min. Spanne	Norm
B	+400°C	+1820°C	100°C	IEC584
E	-100°C	+1000°C	50°C	IEC584
J	-100°C	+1200°C	50°C	IEC584
K	-180°C	+1372°C	50°C	IEC584
L	-100°C	+900°C	50°C	DIN 43710
N	-180°C	+1300°C	50°C	IEC584
R	-50°C	+1760°C	100°C	IEC584
S	-50°C	+1760°C	100°C	IEC584
T	-200°C	+400°C	50°C	IEC584
U	-200°C	+600°C	50°C	DIN 43710
W3	0°C	+2300°C	100°C	ASTM E988-90
W5	0°C	+2300°C	100°C	ASTM E988-90

Vergleichstellenkompensation (CJC)..... < ±1,0 °C
 Externe CJC mit Ni100 oder Pt100 -40 ≤ T_{Umg.} ≤ 135 °C
 Fühlerfehlererkennung Ja
 Fühlerfehlerstrom:
 Bei Erkennung Nom. 33 µA
 Sonst 0 µA
 Kurzschlusserkennung Falls 0% > 5 mV

Spannungseingänge:
 Messbereich -800...+800 mV
 Min. Messbereich (Spanne)..... 2,5 mV
 Eingangswiderstand 10 MΩ

Stromausgänge:
 Signalbereich..... 4...20 mA
 Min. Signalbereich..... 16 mA
 Aktualisierungszeit 440 ms
 (660 ms für Diff.)
 Festes Ausgangssignal Zwischen 4 und 20 mA
 Ausgangssignal bei EEPROMfehler ≤ 3,5 mA
 Belastungswiderstand..... ≤ (U_{Vers.} - 8) / 0,023 [Ω]
 Belastungsstabilität < ±0,01% d. Messsp. / 100 Ω

Sensorfehlanzeige:

Programmierbar 3,5...23 mA
 NAMUR NE43 aufsteuernd 23 mA
 NAMUR NE43 zusteuernd 3,5 mA

Ex- / I.S.-Daten:

Ausgang, Klemme 11...14, (21...24):
 U_i : 28 VDC
 I_i : 120 mADC
 P_i : 0,84 W
 L_i : 10 µH
 C_i : 1,0 nF

Eingang, Klemme 41...44, (51...54):
 U_o : 9,6 VDC
 I_o : 28 mADC
 P_o : 67,2 mW
 L_o : 35 mH
 C_o : 3,5 µF

EEx- / I.S.-Zulassung:

DEMKO 99ATEX126961  II 1 G
 EEx ia IIC T1...T6
 Max. Umgebungstemp. für T1...T6 60°C
ATEX, für Anwendung in Zone..... 0, 1 oder 2
 FM, für Anwendung in..... IS, Class I, Div. 1, Group A, B, C, D
 IS, Class I, Zone 0, AEx ia IIC
 Entity, FM Installation Drawing No. 6335QF01
 CSA, für Anwendung in..... IS, Class I, Div. 1, Group A, B, C, D,
 Ex ia IIC
 IS, Class I, Zone 0, AEx ia IIC
 Installation Drawing No. 6335QC02

GOST R Zulassung:

Standard: VNIIM Cert. no. Ross DK.ME48.V01899
 Ex: VNIIFTRI Cert. no. Ross DK.GB06.V00100

Eingehaltene Behördenvorschriften: Norm:

EMC 2004/108/EG
 Emission und Immunität EN 61 326
 ATEX 94/9/EG..... EN 50 014 og EN 50 020
 FM, ASCN 3600, 3611, 3610
 CSA, CAN / CSA C22.2 No. 157, E60079-11, UL 913

d. Messspanne = der gewählten Messspanne

Anschlüsse:

Eingänge:

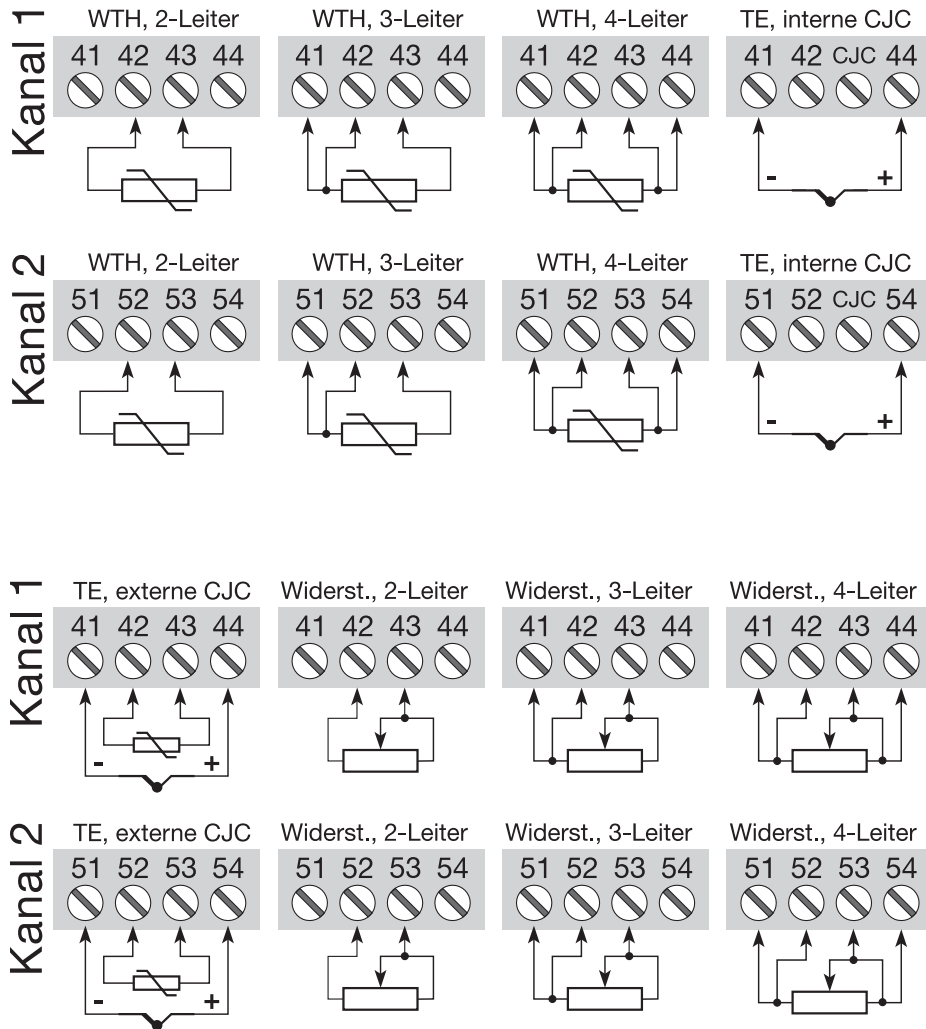

Anschlüsse:

Eingänge:

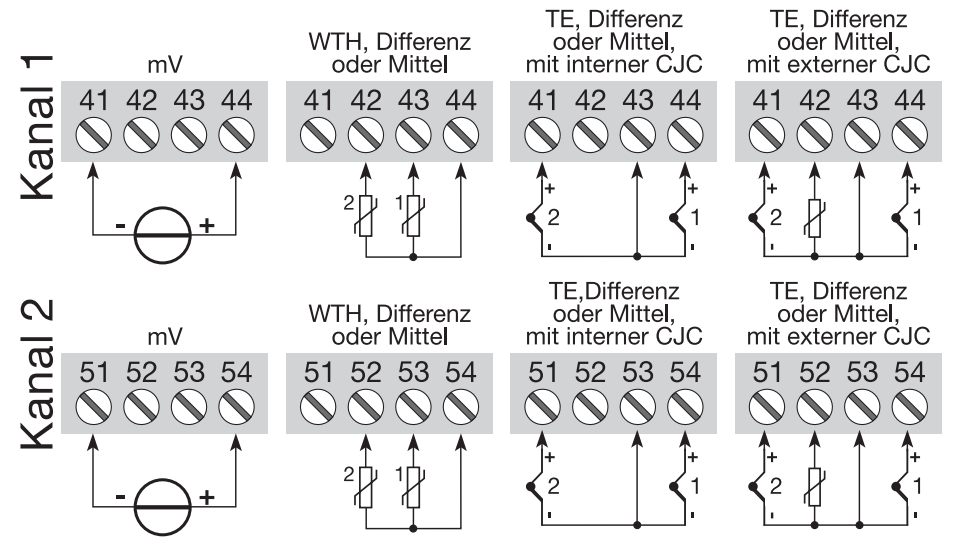

Ausgänge:

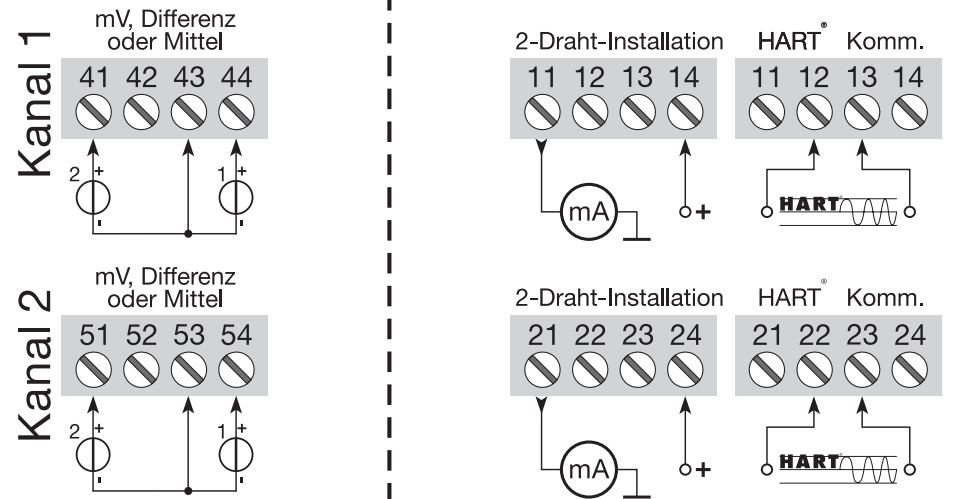

BLOCKDIAGRAMM:

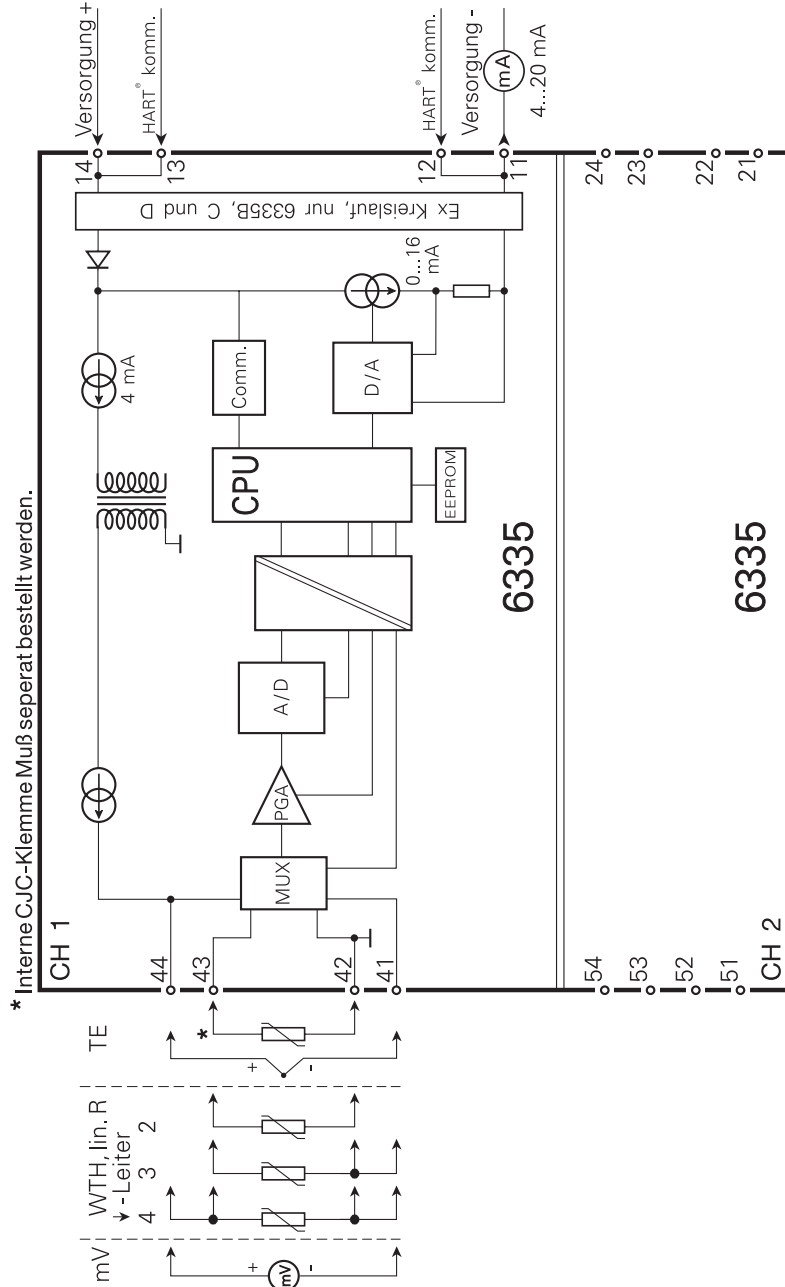

Programmierung:

PReTrans 6335 kann in 3 verschiedener Weise programmiert werden:

1. Mittels PR electronics A/S' Kommunikationsschnittstelle Loop Link und der PReset PC Programmierungssoftware.
2. Mittels eines HART® Modems und der PReset PC Programmierungssoftware.
3. Mittels eines HART® Kommunikator mit dem DDL-Antrieb von PR electronics A/S ausgestattet.

1: Loop Link:

Bezüglich Programmierung verweisen wir auf die nachfolgende Zeichnung und die "Hilfe"-Funktion im PReset-Programm.

- Bei der Kommunikation mit Modulen, die nicht installiert sind, ist es notwendig Stecker 11, 12, 13, 14 (Kanal 1) und 21, 22, 23, 24 (Kanal 2) abzumontieren, um die Verbindungsklemmen der Kommunikationsschnittstelle an die Steckerstifte zu verbinden.

Loop Link darf nicht zur Kommunikation mit Modulen, die in Ex-gefährdeten Bereichen installiert sind, benutzt werden.

Bestellangaben: Loop Link

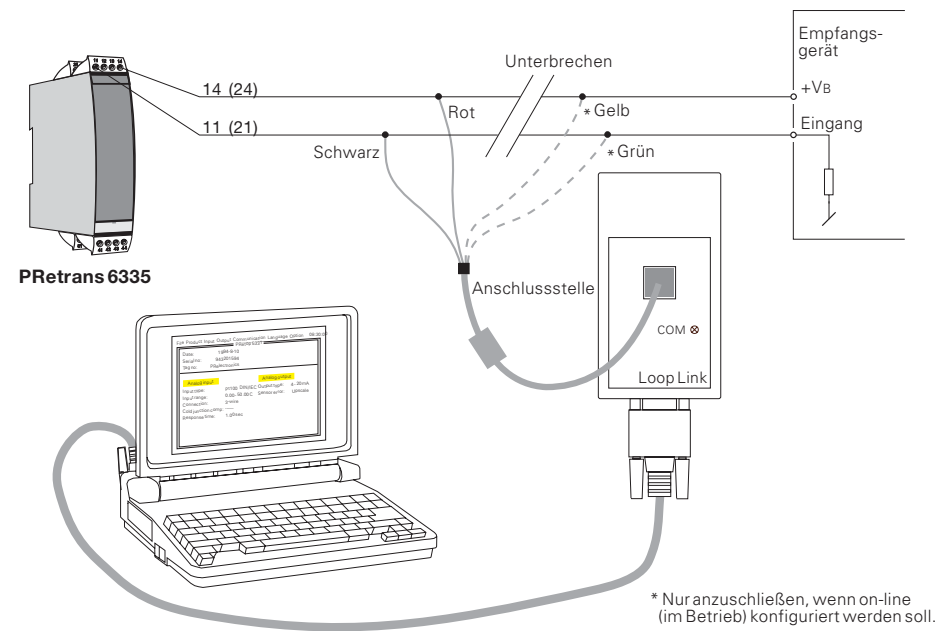

Parallelanschluss von Signalgebern (Multidrop):

- Ein HART[®]-Handterminal oder ein PC-Modem kann über die Punkte AB oder BC angeschlossen werden.
- Im Ausgang können bis zu 15 Signalgeber für eine digitale HART[®] Kommunikation über Zweileiter parallel geschaltet werden
- Jeder Signalgeber wird mit einer unverwechselbaren Nummer von 1 bis 15 konfiguriert. Wenn 2 Signalgeber mit der selben Nummer konfiguriert sind, werden sie beide ignoriert. Die Signalgeber müssen auf Multidropmodus (mit einem festen Ausgangssignal von 4 mA) programmiert werden. Der maximale Strom in der Schleife kann somit 60 mA betragen.
- Die Kommunikation kann über einen HART[®]-Kommunikator oder ein HART[®]-Modem erfolgen.
- Die PReset Software kann den einzelnen Signalgeber auf Multidropmodus einstellen und ihm eine unverwechselbare Adresse für wiederkehrende Abfrage (polling) zuteilen.

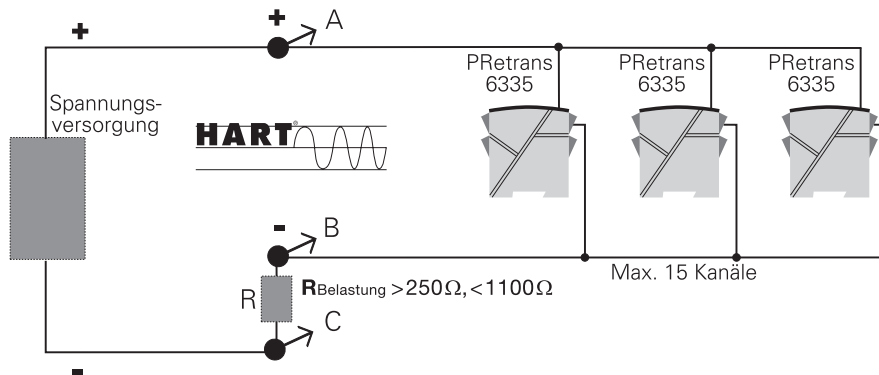

APPENDIX

FM Installation Drawing No. 6335QF01

CSA Installation Drawing No. 6335QC02

Installation Drawing 6335QF01

Model 6335C, 6335D

Hazardous (Classified) Location

Class I, Division 1, Groups, A,B,C,D
 Class II Division 1 Groups E,F,G
 Class I, Zone 0, IIC

Ambient temperature limits
 T6: -40 to + 60 deg. Celsius

Terminal 41,42,43,44
 Vt or Uo: 9,6 V
 It or Io: 28 mA
 Pt or Po: 67.2 mW
 Ca or Co: 3.5 uF
 La or Lo: 35 mH

Terminal 51,52,53,54
 Vt or Uo: 9,6 V
 It or Io: 28 mA
 Pt or Po: 67.2 mW
 Ca or Co: 3.5 uF
 La or Lo: 35 mH

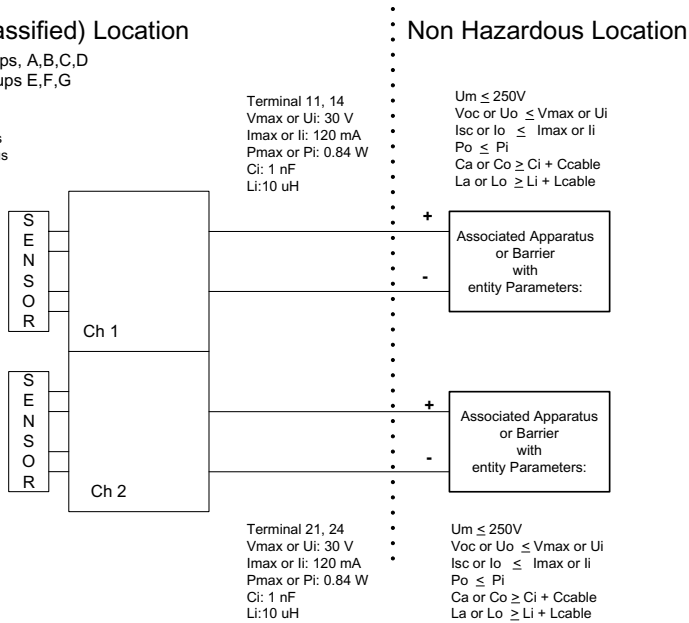

Installation notes.

The Transmitter must be installed in a suitable enclosure to meet installation codes stipulated in The National Electrical Code (ANSI-NFPA 70).

When installed in Class II locations the Transmitter shall be installed in an enclosure with a specified ingress protection of IP6X according to IEC60529 and Dust-tight conduit seals must be used.

Equipment that is FM-approved for intrinsic safety may be connected to barriers based on the ENTITY CONCEPT. This concept permits interconnection of approved transmitters, meters and other devices in combinations which have not been specifically examined by FM, provided that the agency's criteria are met. The combination is then intrinsically safe, if the entity concept is acceptable to the authority having jurisdiction over the installation.

The entity concept criteria are as follows:

The intrinsically safe devices, other than barriers, must not be a source of power.

The maximum voltage $U_i(V_{MAX})$ and current $I_i(I_{MAX})$, and maximum power $P_i(P_{MAX})$, which the device can receive and remain intrinsically safe, must be equal to or greater than the voltage (U_o or V_{OC} or V_t) and current (I_o or I_{SC} or I_t) and the power P_o which can be delivered by the barrier.

The sum of the maximum unprotected capacitance (C_i) for each intrinsically device and the interconnecting wiring must be less than the capacitance (C_a) which can be safely connected to the barrier.

The sum of the maximum unprotected inductance (L_i) for each intrinsically device and the interconnecting wiring must be less than the inductance (L_a) which can be safely connected to the barrier.

The entity parameters U_o, V_{OC} or V_t and I_o, I_{SC} or I_t , and C_a and L_a for barriers are provided by the barrier manufacturer.

CSA Intrinsic Safety Installation Drawing.

6335D transmitters are approved as intrinsically safe in Zone 0 Group IIC or Class I, Division 1, Group A, B, C, D when installed according to Installation Drawing.

1. Connections with separate power supply and receiver.

Output: Standard 4 - 20mA loop

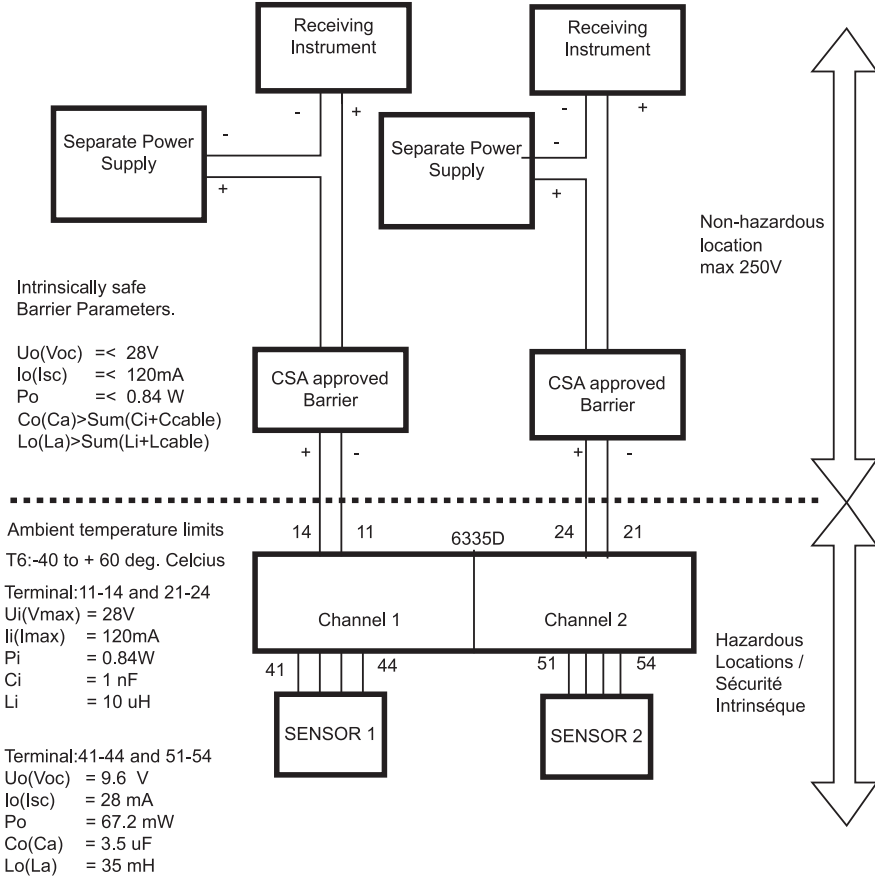

Warning:

Substitution of components may impair intrinsic safety.

Channel 1 and Channel 2 are separate channels and therefore separate shielded cables shall be used for each channel.

The 6335 must be installed in a suitable enclosure to meet installation codes stipulated in the Canadian Electrical Code (CEC).

21-12-2000 6335QC02

1/2

2. Connection with power supply and barrier built into receiver.

Output: Standard 4 - 20mA loop

Intrinsically safe Barrier Parameters.

$U_o(V_{oc}) \leq 28V$
 $I_o(I_{sc}) \leq 120mA$
 $P_o \leq 0.84 W$
 $C_o(C_a) > \sum(C_i + C_{cable})$
 $L_o(L_a) > \sum(L_i + L_{cable})$

Ambient temperature limits
 $T_6: -40 \text{ to } +60 \text{ deg. Celcius}$

Terminal: 11-14 and 21-24
 $U_i(V_{max}) = 28V$
 $I_i(I_{max}) = 120mA$
 $P_i = 0.84W$
 $C_i = 1 \text{ nF}$
 $L_i = 10 \mu H$

Terminal: 41-44 and 51-54
 $U_o(V_{oc}) = 9.6 V$
 $I_o(I_{sc}) = 28 \text{ mA}$
 $P_o = 67.2 \text{ mW}$
 $C_o(C_a) = 3.5 \mu F$
 $L_o(L_a) = 35 \text{ mH}$

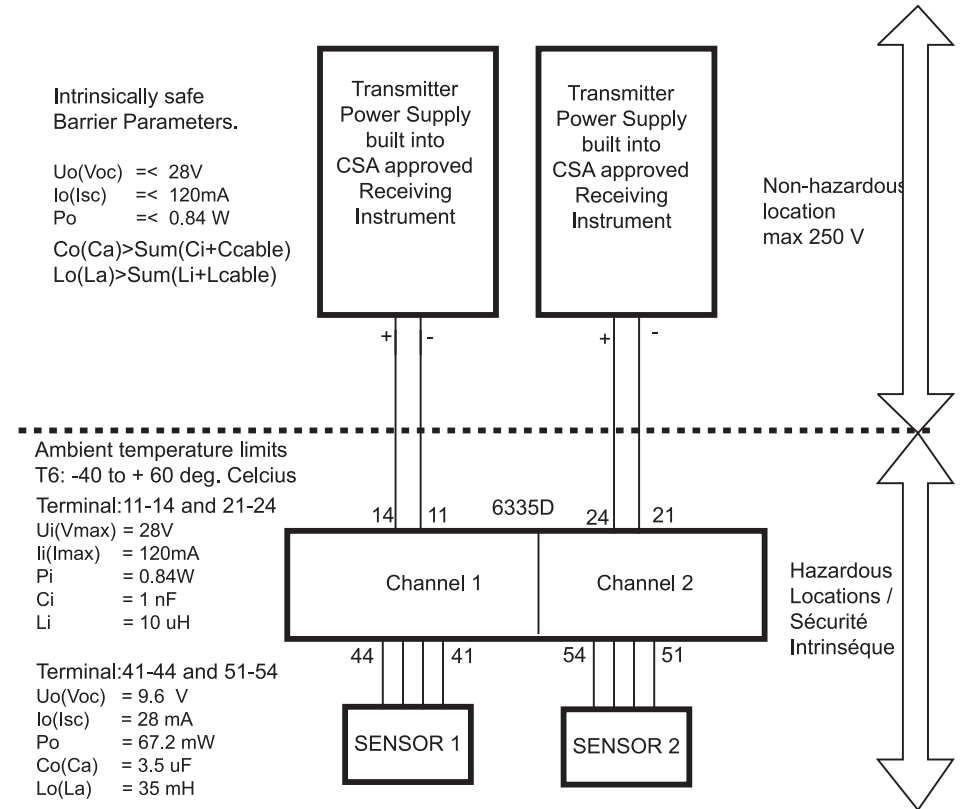

Warning:

Substitution of components may impair intrinsic safety.

Channel 1 and Channel 2 are separate channels and therefore separate shielded cables shall be used for each channel.

The 6335 must be installed in a suitable enclosure to meet installation codes stipulated in the Canadian Electrical Code (CEC).

21-12-2000 6335QC02

2/2

DK ▶ PR electronics A/S tilbyder et bredt program af analoge og digitale signalbehandlingsmoduler til industriel automation. Vores kompetenceområder omfatter: Isolation, Displays, Ex-barrierer, Temperatur samt Universal-moduler. Alle produkter opfylder de strengeste internationale standarder, og størstedelen integrerer den patenterede STREAM-SHIELD teknologi, der sikrer driftssikkerhed i selv de værste omgivelser. Vores motto »Signals the Best« er indbegrebet af denne filosofi – og din garanti for kvalitet.

UK ▶ PR electronics A/S offers a wide range of analogue and digital signal conditioning modules for industrial automation. Our areas of competence include: Isolation, Displays, Ex barriers, Temperature, and Universal Modules. All products comply with the most exacting international standards and the majority feature our patented STREAM-SHIELD technology ensuring reliability in even the worst of conditions. »Signals the Best« is the epitome of our philosophy – and your guarantee for quality.

FR ▶ PR electronics A/S offre une large gamme de produits pour le traitement des signaux analogiques et numériques dans tous les domaines industriels. Nos compétences s'étendent des transmetteurs de température aux afficheurs, des isolateurs aux barrières SI, jusqu'aux modules universels. Tous nos produits sont conformes aux normes internationales les plus strictes et la majorité d'entre eux répondent même à la technologie brevetée STREAM-SHIELD qui garantit un fonctionnement fiable sous les conditions les plus défavorables. Notre devise »SIGNALS the BEST« c'est notre ligne de conduite - et pour vous l'assurance de la meilleure qualité.

DE ▶ PR electronics A/S verfügt über ein breites Produktprogramm an analogen und digitalen Signalverarbeitungsmodulen für die industrielle Automatisierung. Unsere Kompetenzbereiche umfassen: Displays, Temperaturtransmitter, Ex- und galvanische Signaltrenner, und Universalgeräte. Alle Produkte von PR electronics werden in Übereinstimmung mit den strengsten internationalen Normen produziert. Für die Mehrzahl aller Produkte garantiert die patentierte STREAM-SHIELD Technologie höchste Zuverlässigkeit auch unter schwierigsten Einsatzbedingungen. »Signals the Best« ist Ihre Garantie für Qualität!

Subsidiaries

France
PR electronics Sarl
Zac du Chêne, Activillage
2, allée des Sorbiers,
F-69500 Bron
sales@preelectronics.fr
tel. +33 (0) 4 72 14 06 07
fax +33 (0) 4 72 37 88 20

Germany
PR electronics GmbH
Bamlerstraße 92
D-45141 Essen
sales@preelectronics.de
tel. +49 (0) 201 860 6660
fax +49 (0) 201 860 6666

Italy
PR electronics S.r.l.
Via Giulietti, 8
IT-20132 Milano
sales@preelectronics.it
tel. +39 02 2630 6259
fax +39 02 2630 6283

Spain
PR electronics S.L.
Avda. Meridiana 354, 6º-A
E-08027 Barcelona
sales@preelectronics.es
tel. +34 93 311 01 67
fax +34 93 311 08 17

Sweden
PR electronics AB
August Barks gata 6A
S-421 32 Västra Frölunda
sales@preelectronics.se
tel. +46 (0) 3149 9990
fax +46 (0) 3149 1590

UK
PR electronics Ltd
Fairlie Quay Enterprise Park
Main Road, Fairlie
Ayrshire, KA29 0AS
sales@preelectronics.co.uk
tel. +44 (0) 1475 568 000
fax +44 (0) 1475 568 222

USA
PR electronics Inc
16776 Bernardo Center Drive
Suite 203
San Diego, California 92128
sales@preelectronics.com
tel. +1 858 521 0167
fax +1 858 521 0945

Head office

Denmark
PR electronics A/S
Lerbakken 10
DK-8410 Rønne
www.preelectronics.com
sales@preelectronics.dk
tel. +45 86 37 26 77
fax +45 86 37 30 85



QUALITY SYSTEM AND ENVIRONMENTAL MANAGEMENT SYSTEM
DS/EN ISO 9001
DS/EN ISO 14001

